



**Planning Committee**  
**5<sup>th</sup> September 2023**

<b>Application No</b>	:	23/00195/FUL Full Application
<b>Location</b>	:	Garages Rear Of 27 Medway Close Chelmsford Essex
<b>Proposal</b>	:	<b>Demolition of existing garaging and redevelopment to provide 6 new affordable homes with associated access improvements, parking, private amenity space and landscaping.</b>
<b>Applicant</b>	:	D Ford Chelmsford City Council
<b>Agent</b>	:	James Firth
<b>Date Valid</b>	:	2nd February 2023

Appendices:

Appendix 1      Consultations  
Appendix 2      Drawings

## **1. Executive summary**

- 1.1. This application is for six affordable rent dwellings on previously developed land. The land is owned and operated by the City Council. The planning application is made by the City Council. In accordance with the Council's Constitution, the application is presented to the Planning Committee for a decision.
- 1.2. Objections to the application have been received (see Appendix 1). These cover a range of topics including design and character, displacement of parking, flood risk, impact of new resident parking on local roads, access to existing properties and neighbour amenity. All representations and consultee comments have been considered as part of the wider planning considerations of this development proposal. The application assessment concludes the proposal is compliant with the Development Plan.
- 1.3. The application is recommended for approval subject to conditions.

## **2. Description of site**

- 2.1. The application site is located within the Urban Area of Chelmsford. It is comprised of previously developed land, taking the form of hardstanding and garaging, which were originally allocated for residential parking and storage purposes when the wider estate was developed. There are 32 existing garages on site, of which two are still used by existing tenants for the parking of vehicles. The site measures 0.232ha in size.
- 2.2. Access is gained from Medway Close, on the eastern side of the application site. The access runs between the side elevation of No. 30 Medway Close and the adjacent properties to the north-west, along Avon Road.
- 2.3. The eastern and northern boundaries of the site meet the long rear gardens of properties fronting Medway Close and Avon Road. The southern and western boundaries meet undeveloped woodland. There are no protected trees within the vicinity of the site.
- 2.4. Lawford Mead Primary School is located nearby to the application site, as well as local convenience stores on Trent Road. As the site is located within the Urban Area and close by to the City Centre, it is served by bus and rail links.
- 2.5. The site is allocated under Growth Site Policy 1S in the Chelmsford Local Plan.

## **3. Details of the proposal**

- 3.1. This application proposes the construction of a terrace of five, four-bedroom, six-person dwellings and a one-bedroom maisonette over car port spaces (commonly referred to as a FOG unit). All of the proposed dwellings are to be offered for affordable rent.
- 3.2. Two new garages are also proposed to replace the existing garages which are still tenanted on the site.
- 3.3. The application proposes an improved access arrangements into the site, including the widening of the existing site access and provision of a pedestrian walkway. Existing access for

neighbouring residents' rear gardens and one garage is also retained by the proposed development.

- 3.4. Two off-street parking spaces are proposed for the two-storey dwellings under and through car ports, with the FOG unit provided one parking space underneath. Two visitor parking space are also proposed.

#### **4. Summary of consultations**

Public Health & Protection Services: Add ENV07 contaminated land condition. Residential development should provide EV charging infrastructure.

Essex County Council Highways: The proposal is acceptable to the Highway Authority subject to conditions.

Recycling & Waste Collection Services: Raised concerns regarding access for refuse vehicles which have been addressed or can be controlled by condition.

ECC Historic Environment Branch: Condition a Written Scheme of Investigation to be submitted and approved prior to commencement of development.

ECC SUDs: No objection.

Environment Agency: No response.

Local residents: 14 letters of representation (including an unsigned petition) received from local residents all objecting to the proposed development. Concerns raised include:

- Environmental and ecological impacts.
- Increase in noise intrusion.
- Access and safety issues.
- Inadequate parking levels to serve the wider housing estate.
- Harmful to privacy of adjacent neighbouring properties.
- Not in accordance with Development Standards in Appendix B of Chelmsford Local Plan.
- Visual intrusion of development.
- Block light to neighbouring properties.
- Flood risk from surface water.
- Contamination issues.
- Inadequate parking provision.

#### **5. Planning considerations**

##### ***Main Issues***

- 5.1. The application seeks six affordable housing units, making this a 100% affordable housing scheme. All six units would be provided on an affordable rent tenure which can be secured without a legal agreement due to the Council's ownership of the site. In these circumstances affordable housing tenure considerations under Policy DM2 would not apply.
- 5.2. The proposal includes 5 x 4B6P affordable houses for rent which meet the Council's priority housing need. The Council currently has numerous statutory homeless households requiring

four-bedroom accommodation that are currently housed in temporary accommodation awaiting an offer of permanent affordable housing.

- 5.3. The 1B2P flat is also proposed to be provided as affordable rented housing that will meet priority housing needs as there are a considerable number of households in priority housing need on the Housing Register and in temporary accommodation awaiting an offer of one-bedroom affordable accommodation.
- 5.4. The main considerations for this proposal are parking displacement, design, flood risk and neighbour relationships. Other considerations, such as parking and access, technical compliance with development standards and other material considerations also apply.

#### Design and Character

- 5.5. Policy DM23 of the Chelmsford Local Plan states that planning permission will be granted for development that respects the character and appearance of the area in which it is located. Development must be compatible with its surroundings having regard to scale, siting, form, architecture, materials, boundary treatments and landscape. The design of all new buildings and extensions must be of high quality, well proportioned, have visually coherent elevations, active elevations and create safe, accessible and inclusive environments.
- 5.6. The proposed development has been laid out in a similar layout to the existing garages, back-to-back with existing houses to create an additional street to Medway Close. The scale and design of the proposed dwellings reflect the existing character of the area. A development of two-storey dwellings within the context of a suburban residential area containing predominantly two-storey dwellings is considered to be very much in keeping with the prevailing character of the locality.
- 5.7. The proposed development is accompanied by a landscape plan, which details the proposed scheme of shrub and tree planting; as well as boundary treatments including walls and close boarded fences. These measures are proposed to soften the impact of the development and assist in integrating the site into its context.
- 5.8. The proposal complies with Policy DM23 of the Chelmsford Local Plan.

#### Neighbouring Impacts

- 5.9. Policy DM29 of the Chelmsford Local Plan states that Development proposals must safeguard the amenities of the occupiers of any nearby residential property by ensuring that development is not overbearing and does not result in unacceptable overlooking or overshadowing. Development must also avoid unacceptable levels of polluting emissions, unless appropriate mitigation measures can be put in place and permanently maintained.
- 5.10. Concern has been raised from local residents that the proposed development would have a harmful impact on the existing properties on Avon Road, to the north of the site, and Medway Close, to the east.
- 5.11. The distances between the proposed dwellings and the end of the rear gardens of the existing dwellings is roughly 10 metres. Whilst the Local Plan Appendix B recommends a distance of 15 metres, it should be noted that the rear gardens of the existing properties are relatively long (over 25 metres). As such, the majority of the garden areas of these properties are over the 15m

recommended distance from first floor windows in the proposed development. Furthermore, the back-to-back distances between the proposed dwellings and the existing development to the north exceed 30m. This exceeds the recommended minimum distance for two/three storey developments' rear or front-facing windows serving habitable rooms on upper floors of 25m, as per Appendix B of the Chelmsford Local Plan.

- 5.12. The applicant has also responded to representations during the lifetime of the application to reduce harm to neighbours. As such, the amount of habitable rear room windows has been reduced from two to one, further limiting perceived harm to these existing properties. The flank wall of Plot 5 to the east does not contain first floor windows and is over 27m to nearest property.
- 5.13. Local residents have raised that the proposed development would increase noise pollution to existing properties. Although any development would proportionately increase noise in an area, this would be extremely minimal owing to the residential nature of use and considered in context with a residential setting. A refusal of planning permission could not be justified on this basis. This area is appropriate for new residential development.
- 5.14. For these reasons, the proposal complies with Policy DM29 of the Chelmsford Local Plan.

#### Parking Provision, Access and Displacement

- 5.15. The Local Highway Authority has been consulted on these proposals and has raised no objections but has recommended several planning conditions to scope and manage works affecting the highway.
- 5.16. The scheme contains six residential units with provision of 14 car parking spaces (including four visitor spaces). The site is within the Urban Area close to local amenities and city centre. This balance of travel provision in such a sustainable location is acceptable and is supported by the Local Highway Authority.
- 5.17. The proposed development incorporates on-site parking that meets the Essex Parking Standards. The Council's Making Spaces Supplementary Planning Document reiterates that the Essex Parking Standards will be used, but states these may be relaxed "in urban locations with high levels of public transport accessibility". There are good public transport links locally, but these are a short walk from the site. As such, the proposed provision of car parking is considered appropriate.
- 5.18. The Transport Statement submitted with the application has considered existing parking provision within a 100m radius of the application site, to establish whether residents, including those who may have used the garages proposed to be demolished, will have alternative places to park on-street. Whilst it should be noted that the garages are not in use presently for parking, this confirmed that sufficient spaces are available. In addition, the survey demonstrates that the loss of spaces from a Traffic Regulation Order restricting car parking at the end of Medway Close to facilitate larger vehicle access to the site (e.g. refuse freighter or fire tender) would not result in undue parking stress.
- 5.19. Acknowledging that local concern has been raised about existing parking pressures within Medway Close, the consideration to be applied is whether this proposal would exacerbate these issues. Whilst the existing parking stresses have been considered, the proposed development would provide policy compliant levels of parking in excess of minimum provision based on

proximity to city centre and other facilities. The existing garages on site are not, in practice, used for car parking and the proposed development incorporates sufficient parking for future occupiers and visitors. As such, the proposed development is not considered to give rise to any additional material impact on parking in the local area.

- 5.20. Access to the site is to be taken from Medway Close in the same position to the existing car park access. No matters of principle arise from this proposal and the works, including a Traffic Regulation Order, will need further agreement by the Local Highway Authority which is covered by separate highways legislation.
- 5.21. The site is to be serviced (e.g. refuse collection) from the within the site. Submitted with the application is a refuse and recycling strategy plan which confirms that all of the units have legible pathways from on-plot storage to the shared bin collection point which is suitably accessible to operatives from the street. Bin stores and collection point will be required by condition to ensure that there is adequate provision to serve the development.

#### Development Standards

- 5.22. Policy DM26 of the Chelmsford Local Plan states that all new dwellings shall have sufficient privacy, amenity space, open space, refuse and recycling storage and shall adhere to the Nationally Described Space Standards. These must be in accordance with Appendix B.
- 5.23. The development is compliant with the Nationally Described Space Standards for housing.
- 5.24. Five out of the six dwellings will meet the requirements of Part M4(2) of Building Regulations 2015. The 1-bed unit will meet Part M4(1) requirements. Whilst not required specifically for a development of this scale, this level of accessibility will be a significant benefit for these affordable homes and ensuring they meet a range of user needs and requirements.
- 5.25. Electric Vehicle charging will be required for each plot.
- 5.26. The proposals also meet the requirements of the Council's Development Standards (Appendix B) in respect of garden sizes and parking provision.

#### Trees, Biodiversity Enhancements and RAMS

- 5.27. Submitted with the application is a tree report concluding that development would have no significant impact on surrounding trees. There is a short section of independent hedgerow and two C Category trees within the site which will be removed to facilitate development. These are of low value. The development has been largely designed to avoid impact on tree roots, but methodologies would nonetheless be required, which can be secured by condition.
- 5.28. The Ecology Appraisal submitted with the application does not conclude further assessment or survey is required. This conclusion is agreed. The specification of landscaping and recommendations for other ecological betterment will be secured by planning condition. Net biodiversity gain is achieved via the landscaping scheme.
- 5.29. The Conservation of Habitats and Species Regulations 2017, as amended (commonly known as the Habitat Regulations) require all new residential developments that have the potential to cause disturbance to European designated sites to provide appropriate mitigation. To deal with this, an Essex County wide strategic approach to considering and mitigating potential harm has

been produced - the Essex Coast Recreational Disturbance Avoidance and Mitigation Strategy (RAMS). An Appropriate Assessment has been carried out which concludes that a contribution towards off-site mitigation (RAMS contribution) is necessary to mitigate the potential disturbance to European designated sites arising from this development growth. A RAMS payment of £940.56 has been agreed with the Council's Corporate Property Manager, which is in line with the prevailing rate.

### Tree Planting

- 5.30. The Council has declared a Climate and Ecological Emergency to focus attention on reducing carbon and greenhouse gas emissions in the area and to plan for a more sustainable future. The Council's Climate and Ecological Emergency Action Plan includes undertaking a greening programme to significantly increase the amount of woodland and the proportion of tree cover in Chelmsford. Paragraph 5.18 of the Making Places Supplementary Planning Document (January 2021) states that green spaces provided in connection with new housing development should, where practicable, include the planting of three trees per net new dwelling. The proposed plans show that 18 new trees (three for each dwelling) will be planted within the application site. These will be secured as part of the conditioned landscaping scheme.

### Flood Risk

- 5.31. The Application is accompanied by a Flood Risk Assessment (FRA) and Drainage Strategy prepared by Create. A full FRA has been undertaken given the site's location in a Critical Drainage Area (NCLF\_001 St Andrews South Critical Drainage Area).
- 5.32. There are a number of surface water flow paths within the site and as such there is a risk of surface water flooding. As a result of this however, the built form has been situated away from the primary routes, and also raised in floor level (300-350mm over existing ground levels for Plots 1-4, and 400-500mm for Plots 5 and 6). Plot 6 (raised flat over a garage) will have a sacrificial ground floor footprint. A full scheme of mitigation measures is provided within the accompanying Flood Risk Assessment and Drainage Strategy report.
- 5.33. The assessments undertaken demonstrate that the risk of flooding from all sources is generally low, and the development can be operated safely without significantly increasing flood risk elsewhere. Some residual risks have been identified but appropriate mitigation measures proposed to manage these.
- 5.34. The Lead Local Flood Authority (LLFA) Essex County Council have been consulted on and do not object to the proposals.
- 5.35. The development will therefore be safe from flooding and will not increase flood risk elsewhere in accordance with adopted Policy DM18.

## **6. Community Infrastructure Levy (CIL)**

- 6.1. This development is CIL liable. CIL payments are required to help pay for general infrastructure arising from development. In addition, there is a requirement for specific payments towards works which would usually be made via a S.106 agreement, but as this is a Council-owned site those contributions (RAMS) have been secured as direct transfer between Council Services, to be undertaken when planning permission is in place.

## **7. Conclusion**

- 7.1. The proposals are a sustainable use of previously developed land in the Urban Area.
- 7.2. The development will have a positive impact on housing and affordable housing in the city.
- 7.3. Local objections have been received and considered. The matters raised through the consultation have been considered in the context of national and local planning policy. The objections would not amount to grounds for refusal as the development is assessed to be acceptable in relation to those concerns raised.
- 7.4. The proposals are compliant with the standards and objectives of the National Planning Policy Framework and Chelmsford Local Plan (May 2020). Across all material planning considerations the development is assessed to be acceptable.
- 7.5. Officers recommend the application is approved subject to conditions.

### **RECOMMENDATION**

**The Application be APPROVED subject to the following conditions:-**

#### **Condition 1**

The development hereby permitted shall begin no later than 3 years from the date of this decision.

Reason:

In order to comply with Section 91(1) of the Town and Country Planning Act 1990 as amended by Section 51 of the Planning and Compulsory Purchase Act 2004.

#### **Condition 2**

The development hereby permitted shall be carried out in accordance with the approved plans and conditions listed on this decision notice.

Reason:

In order to achieve satisfactory development of the site

#### **Condition 3**

Prior to their use, details of the materials to be used in the construction of the development hereby permitted shall be submitted to and approved in writing by the local planning authority. The development shall then be carried out in accordance with the approved details.

Reason:

To ensure that the development is visually acceptable in accordance with Policy DM23 of the Chelmsford Local Plan.

#### **Condition 4**

The six (6) dwellings in this development shall not be used for any purpose other than the provision of Affordable Housing within the definition as given within the National Planning Policy Framework.

Reason:

To define the scope of the planning permission as being a 100% Affordable Housing scheme.



**Condition 5**

a) No development shall take place until a scheme to assess and deal with any contamination of the site has been submitted to and approved in writing by the local planning authority.

b) Prior to the occupation or first use of the development, any remediation of the site found necessary shall be carried out, and a validation report to that effect submitted to the local planning authority for written approval and the development shall be carried out in accordance with that scheme.

Reason:

This information is required prior to the commencement of the development because this is the only opportunity for contamination to be accurately assessed. This is to ensure the development does not give rise to problems of pollution or contamination in accordance with Policy DM30 of the Chelmsford Local Plan.

**Condition 6**

Prior to the first occupation of the dwelling/s hereby permitted, charging infrastructure for electric vehicles shall be installed and retained at a rate of 1 charging point per dwelling.

Reason:

To ensure that the development is constructed sustainably in accordance with Policy DM25 of the Chelmsford Local Plan.

**Condition 7**

All new dwelling units as hereby approved shall be constructed to achieve increased water efficiency to a standard of no more than 110 litres of water per person per day in accordance with Building Regulations Approved Document Part G (2015 - as amended).

Reason:

To ensure the development reduces water dependency in accordance with Policy DM25 of the Chelmsford Local Plan.

**Condition 8**

All mitigation measures and/or works shall be carried out in accordance with the details contained in the Preliminary Ecological Appraisal (James Blake Associates, October 2022) as submitted with the planning application and agreed in principle with the local planning authority prior to determination.

Reason:

To conserve protected and Priority species and allow the LPA to discharge its duties under the Conservation of Habitats and Species Regulations 2017 (as amended), the Wildlife & Countryside Act 1981 as amended and s40 of the NERC Act 2006 (Priority habitats & species).

**Condition 9**

No unbound material shall be used in the surface treatment of the vehicular access hereby permitted within 6 metres of the highway boundary.

Reason:

To avoid displacement of loose material onto the highway in the interests of highway safety.

**Condition 10**

The area/s of hardsurfacing hereby permitted shall be constructed using a permeable surface or shall include drainage to prevent discharge of surface water onto the Highway.

Reason:

To prevent hazards caused by water flowing onto the highway and to avoid the formation of ice on the highway in the interest of highway safety.

**Condition 11**

No dwelling shall be occupied until space has been laid out within the site in accordance with Drawing No. 3556:02/G for fourteen (14) cars to be parked and that space shall thereafter be kept available at all times for the parking of vehicles.

Reason:

To ensure that sufficient parking is available to serve the development in accordance with Policy DM27 of the Chelmsford Local Plan.

**Condition 12**

Prior to the construction of any access roads, a plan to show how the development will be serviced by a refuse vehicle shall be submitted to and approved in writing by the local planning authority. All roads shown on the approved drawing to be served by a refuse collection vehicle shall be constructed to a standard capable of carrying a 26 tonne vehicle.

Reason:

In the interests of highway safety and to ensure that the development is accessible in accordance with Policy DM23 [and DM24] of the Chelmsford Local Plan.

**Condition 13**

No development shall take place, including any ground works or demolition, until a Construction Management Plan has been submitted to, and approved in writing by, the Local Planning Authority. The approved plan shall be adhered to throughout the construction period. The Plan shall provide for:

- i. The parking of vehicles of site operatives and visitors,
- ii. Loading and unloading of plant and materials,
- iii. Storage of plant and materials used in constructing the development,
- iv. Wheel and underbody washing facilities.
- v. Before and after condition survey to identify defects to highway in the vicinity of the access to the site and where necessary ensure repairs are undertaken at the developer expense where caused by developer.

Reason:

To ensure that on-street parking of these vehicles in the adjoining streets does not occur and to ensure that loose materials and spoil are not brought out onto the highway in the interests of highway safety.

**Condition 14**

Prior to first occupation of the development, the vehicular area turning facility, shown in Approved Drawing No. 3556:02/G shall be constructed, surfaced and maintained free from obstruction within the site at all times for that sole purpose.

Reason:

To ensure that vehicles can enter and leave the highway in a forward gear in the interest of highway safety.

**Condition 15**

The first-floor rear windows in the northern rear elevations of Plots 1-5, serving bathrooms, and shown on approved Drawing No. 3556:02/H shall be:

- a) obscured (minimum Level 3 obscurity level) and
- b) of a design not capable of being opened below a height of 1.7m above finished floor level and shall remain so obscured and non-openable.

Reason:

To safeguard the privacy of the occupiers of the adjacent property or properties in accordance with Policy DM29 of the Chelmsford Local Plan.

#### **Condition 16**

Notwithstanding the provisions of the Town and Country Planning (General Permitted Development) Order 2015 (or any Order revoking or re-enacting that Order with or without modification), the dwellings hereby permitted shall not be enlarged or extended without the grant of an additional planning permission by the local planning authority.

Reason:

To ensure that the development remains contextualised to its surroundings and to ensure that adequate private amenity space is retained for the dwellings in accordance with Policies DM23 and DM26 of the Chelmsford Local Plan.

#### **Condition 17**

Notwithstanding the drawings as approved:

(i) Within 6 months of commencement of development the proposed treatment of all boundaries (external and internal site subdivision), including representative drawings of gates, fences, walls, railings or piers shall have been submitted to and approved in writing by the local planning authority.

(ii) No part of the development shall be occupied until boundary treatments as approved under (i) of this condition have been installed in accordance with those agreed details.

Reason:

In the interests of the visual amenities of the area in accordance with Policies DM23 and DM29 of the adopted Chelmsford Local Plan (May 2020).

#### **Condition 18**

Notwithstanding the approved drawings, within 6 months of commencement of development a comprehensive specification of all hard and soft landscaping works and content shall have been submitted to and approved in writing by the local planning authority to include written specification, layouts and large-scale drawings as necessary of the following:

- i. hard materials setting out (including laying patterns),
- ii. details of any steps/ramps,
- iii. lighting (to streets/spaces),
- iv. existing trees, hedges or other soft features to be retained,
- v. definitive planting specification containing species and sizes,
- vi. tree pits, root barriers and staking,
- vii. any in-built method(s) of irrigation
- viii. maintenance plan(s) for all of the above

All external areas of the development as approved shall be laid out, planted, equipped and implemented in accordance with the agreed specifications prior to the occupation of 90% of the approved dwellings unless

the local planning authority formally agrees to a varied timetable and shall be permanently retained thereafter in accordance with a management plan, as approved.

If within a period of 5 years from the date of planting any element of the soft landscaping scheme or retained landscaping (or any replacement planting to which this same provision would also apply), is removed, uprooted, or destroyed, or becomes, in the opinion of the local planning authority, seriously damaged or defective, another tree or landscaping feature of the same size and species as that originally planted shall be planted at the same place, unless the local planning authority gives its written consent to any variation.

Reason:

Whilst drawings 3556:02/G and 004/D provide detail sufficient to determine the application, further information is required to ensure the specification of external areas sufficient. Implementation in accordance with full details is necessary to comply with Policies DM13, DM16 and DM23 of the adopted Chelmsford Local Plan (May 2020).

### **Condition 19**

Prior to the occupation of any of the proposed dwellings, the proposed private drive shall be constructed as shown in Approved Drawing No. 3556:02/G and provided with a suitable dropped kerb crossing of the existing footway/verge. The construction works shall be regulated by an appropriate legal agreement with the Highway Authority, which will provide for but not be limited to the following:

- i. A footway transition into the site on the south side of the vehicular access, connecting to the existing Medway Close footway.
- ii. Clear to ground vehicular visibility splays of 2.4 metres x 43 metres in both directions, to be maintained in perpetuity.
- iii. Unless the Local Planning Authority agrees to a commensurate solution, provision of Traffic Regulation Order (TRO) parking restrictions to prevent parking on Medway Close to each side of the vehicular access to the north and the south and opposite the vehicular access on the east side of Medway Close to facilitate refuse vehicle entry to the development, in accordance with details to be agreed with the Highway Authority.
- iv. Provision of all signing and lining in association with the highway works.

Reason:

To provide appropriate footway connection, adequate inter-visibility between vehicles using the road junction and those in the existing public highway and to facilitate entry/exit of refuse vehicles, in the interest of highway safety.

### **Condition 20**

- i) No development or preliminary groundworks of any kind shall take place until a programme of archaeological investigation has been secured in accordance with a Written Scheme of Investigation which has been submitted by the applicant, and approved in writing by the local planning authority.
- ii) No development or preliminary groundworks of any kind shall take place until the completion of the programme of archaeological investigation identified in the Written Scheme of Investigation defined in (i) above.
- iii) The applicant will submit to the local planning authority a post excavation assessment (to be submitted within six months of the completion of the fieldwork, unless otherwise agreed in advance with the Planning Authority). This will result in the completion of post excavation analysis, preparation of a full site archive and report ready for deposition at the local museum, and submission of a publication report.

Reason:

This information is required prior to the commencement of the development because this is the only opportunity for archaeological investigation work to be undertaken. These works are required to ensure that adequate archaeological records can be made in respect of the site in accordance with Policy DM15 of the Chelmsford Local Plan.

**Condition 21**

No development shall take place within the root protection area of trees as shown on drawing number JBA 22 119 TCP01 Rev A (forming part of the Arboricultural Impact Assessment) until an arboricultural method statement setting out arrangements for the building operations and excavations within the root protection area of the affected trees has been submitted to and approved in writing by the local planning authority. The development shall then be carried out in accordance with the approved details.

Reason:

The use of the correct excavation methods will ensure that the tree roots are not damaged in order to safeguard the existing trees in accordance with Policy DM17 of the Chelmsford Local Plan.

**Condition 22**

No part of the development shall be occupied until the approved refuse and recycling storage has been made available and shall thereafter be maintained in a good state of function and cleanliness for its intended use as approved. The bin collection point("BCP") as shown on drawing 3556:02 Rev G shall be used for staging of bin/recycling receptacles for collection only and shall at all other times remain clear.

Reason:

To ensure satisfactory waste and recycling and collection points are available to all occupiers in accordance with Policy DM26 of the adopted Chelmsford Local Plan (May 2020).

**Condition 23**

Prior to the first occupation of each respective unit within the development covered and secure cycle parking for those residents shall be created and be made available for use. Those spaces shall thereafter be kept available for the parking of cycles only.

Reason:

To ensure adequate cycle provision is available in accordance with Policy DM27 of the Chelmsford Local Plan (May 2020).

**Notes to Applicant**

- 1 In order to cause minimum nuisance to neighbours, the applicant is strongly advised to follow guidelines for acceptable working hours set out by the Council's Public Health and Protection team.

Noisy work

- Can be carried out between 0800 and 1800 Monday to Friday
- Limited to 0800-1300 on Saturdays
- At all other times including Sundays and Bank Holidays, no work should be carried out that is audible beyond the boundary of the site

Light work

- Acceptable outside the hours shown above
- Can be carried out between 0700 and 0800; and 1800-1900 Monday to Friday

In some circumstance further restrictions may be necessary.

For more information, please contact Chelmsford City Council Public Health and Protection Services, or view the Council's website at [www.chelmsford.gov.uk/construction-site-noise](http://www.chelmsford.gov.uk/construction-site-noise)

- 2 The proposed development may be liable for a charge under the Community Infrastructure Levy Regulations 2010 (as Amended). If applicable, a Liability Notice will be sent as soon as possible to the applicant and any other person who has an interest in the land. This will contain details of the chargeable amount and how to claim exemption or relief if appropriate. There are further details on this process on the Council's website at [www.chelmsford.gov.uk/cil](http://www.chelmsford.gov.uk/cil), and further information can be requested by emailing [cilenquiries@chelmsford.gov.uk](mailto:cilenquiries@chelmsford.gov.uk). If the scheme involves demolition, for the purposes of the Regulations the development will be considered to have begun on commencement of the demolition works.
- 3 Please note that the Council will contact you at least annually to gain information on projected build out rates for this development. Your co-operation with this request for information is vital in ensuring that the Council maintains an up to date record in relation to Housing Land Supply.
- 4 This permission is subject to conditions, which require details to be submitted and approved by the local planning authority. Please note that applications to discharge planning conditions can take up to eight weeks to determine.
- 5 This development will result in the need for a new postal address. Applicants should apply in writing, email or by completing the online application form which can be found at [www.chelmsford.gov.uk/streetnaming](http://www.chelmsford.gov.uk/streetnaming). Enquires can also be made to the Address Management Officer by emailing [Address.Management@chelmsford.gov.uk](mailto:Address.Management@chelmsford.gov.uk)
- 6 The Local Highway Authority (Essex County Council) must be contacted regarding the details of any works affecting the existing highway. Contact details are: Telephone: 0845 603 7631. Email: [development.management@essexhighways.org](mailto:development.management@essexhighways.org).

### **Positive and Proactive Statement**

During the life of the application the Local Planning Authority suggested amendments to the proposal in order to improve the development. The Local Planning Authority has assessed the proposal against all material considerations including planning policies and any comments that may have been received. The planning application has been approved in accordance with the objectives of the National Planning Policy Framework to promote the delivery of sustainable development and to approach decision taking in a positive way.

## **SUMMARY OF RELEVANT ADOPTED PLANNING POLICIES:**

### **DM2A**

Policy DM2 (A) - Affordable Housing & Rural Exception Sites - The Council will require the provision of 35% of the total number of residential units to be provided and maintained as affordable housing within all new residential sites which comprise 11 or more residential units.

### **DM23**

Policy DM23 - High Quality & Inclusive Design - Planning permission will be granted for development that respects the character and appearance of the area in which it is located. Development must be compatible with its surroundings having regard to scale, siting, form, architecture, materials, boundary treatments and landscape. The design of all new buildings and extensions must be of high quality, well proportioned, have visually coherent elevations, active elevations and create safe, accessible and inclusive environments.

### **DM29**

Policy DM29 - Protecting Living & Working Environments - Development proposals must safeguard the amenities of the occupiers of any nearby residential property by ensuring that development is not overbearing and does not result in unacceptable overlooking or overshadowing. Development must also avoid unacceptable levels of polluting emissions, unless appropriate mitigation measures can be put in place and permanently maintained.

### **APPB**

Appendix B forms part of the adopted Local Plan and provides information about standards that apply to all new residential developments in Chelmsford including conversions, apartments, houses, Houses in Multiple Occupation (HMO's) and extensions, unless it can be demonstrated that the particular site circumstances require a different design approach. The standards seek to ensure new developments will meet the needs of their occupiers, minimise the impact of new developments on surrounding occupiers and encourage higher rates of recycling.

### **MPSPD**

The Making Places Supplementary Planning Document was adopted in January 2021 and sets out detailed guidance for the implementation of the policy requirements set out in the Local Plan. It seeks to promote and secure high-quality sustainable new development. It is aimed at all forms of development, from large strategic developments, public spaces and places, to small extensions to individual homes.

### **DM27**

Policy DM27 - Parking Standards - The Council will have regard to the vehicle parking standards set out in the Essex Parking Standards - Design and Good Practice (2009) or as subsequently amended when determining planning applications.

### **DM26**

Policy DM26 - Design Specification for Dwellings - All new dwellings (including flats) shall have sufficient privacy, amenity space, open space, refuse and recycling storage and shall adhere to the Nationally Described Space Standards. These must be in accordance with Appendix B. All houses in multiple occupation shall also provide sufficient communal garden space, cycle storage, parking and refuse and waste storage.

### **DM16**

Policy DM16 - Ecology & Biodiversity - The impact of a development on Internationally Designated Sites, Nationally Designated Sites and Locally Designated Sites will be considered in line with the importance of the

site. With National and Local Sites, this will be balanced against the benefits of the development. All development proposals should conserve and enhance the network of habitats, species and sites.

#### DM30

Policy DM30 - Contamination & Pollution - Permission will only be granted for developments on or near to hazardous land where the Council is satisfied there will be no threat to the health or safety of future users and there will be no adverse impact on the quality of local groundwater or surface water. Developments must also not have an unacceptable impact on air quality and the health and wellbeing of people.

#### DM25

Policy DM25 - Sustainable Buildings - All new dwellings and non-residential buildings shall incorporate sustainable design features to reduce carbon dioxide and nitrogen dioxide emissions and the use of natural resources. New dwellings and non-residential buildings shall provide convenient access to electric vehicle charging point infrastructure.

#### DM18

Policy DM18 - Flooding/Suds - Planning permission for all types of development will only be granted where it can be demonstrated that the site is safe from all types of flooding. All major developments will be required to incorporate water management measures to reduce surface water run off and ensure that it does not increase flood risk elsewhere.

### **Background Papers**

Case File

---



## Public Health &amp; Protection Services

Comments
<p>22.02.2023 - Please put on an ENV07 condition. The Phase 1 Assessment has identified the need for an intrusive investigation.</p> <p>An asbestos survey must be undertaken prior to demolition. Any asbestos found must be removed by a suitably qualified contractor and disposed of at a licensed facility. Duty of care documentation must be provided.</p> <p>This residential development should provide EV charging point infrastructure to encourage the use of ultra-low emission vehicles at the rate of 1 charging point per unit (for a dwelling with dedicated off-road parking) and/or 1 charging point per 10 spaces (where off-road parking is unallocated).</p>

## Essex County Council Highways

Comments
<p>14.03.2023 - Your Ref: 23/00195/FUL</p> <p>Our Ref: CO/EGD/SD/RM/CHL/23/195/53802</p> <p>Date:- 14th March 2023</p> <p>' The development site is a 32no. garage site, where the vast majority of the garages are abandoned or disused.</p> <p>o Note that the 2no. garages that are currently in use, would be re-provided as part of the scheme. See condition 7 in the recommendation below.</p> <p>' The proposal is for 6no dwellings; 5no. four bedroom dwellings and 1no. one bedroom dwelling:</p> <p>o 14no. Parking Spaces in accordance with the Parking Standards are provided:</p> <p>o Each dwelling is provided with off-street parking in accordance with the parking standards (11no. parking spaces; 2no. for Plot 1 to 5 and 1no. for the Plot 6, the apartment).</p> <p>o Separate additional unallocated 3no. visitor parking spaces are provided.</p>

' A Parking Beat Survey of available kerbside residential parking space in the surrounding streets (Medway Close, Avon Road and Thames Avenue) within 100 metres of the development site (and not restricted by TRO), was carried out Tuesday 29th and Wednesday 30th November 2022 and Saturday 3rd December 2022.

o The survey identified there is space to accommodate 84no. vehicles.

o The survey summary identified:

' The highest on-street parking level of 36no. vehicles (43%) Wednesday 13:00hrs (48no. available).

' The lowest on-street parking level of 29no. vehicles (35%) Saturday 16:00hrs (55no. available).

o This level of available on-street parking space means that any displaced parking from the development, would very likely not result residential kerbside parking stress.

' The private drive and estate road would not meet Highway Authority criterion for adoption at public expense.

From a highway and transportation perspective the impact of the proposal is acceptable to the Highway Authority subject to the following conditions:

1. No development shall take place, including any ground works or demolition, until a Construction Management Plan has been submitted to, and approved in writing by, the local planning authority. The approved plan shall be adhered to throughout the construction period. The Plan shall provide for;

i. the parking of vehicles of site operatives and visitors,

ii. loading and unloading of plant and materials,

iii. storage of plant and materials used in constructing the development,

iv. wheel and underbody washing facilities.

v. Before and after condition survey to identify defects to highway in the vicinity of the access to the site and where necessary ensure repairs are undertaken at the developer expense where caused by developer.

Reason: To ensure that on-street parking of these vehicles in the adjoining streets does not occur and to ensure that loose materials and spoil are not brought out onto the highway in the interests of highway safety and Policy DM1.

2. Prior to the occupation of any of the proposed dwellings, the proposed private drive shall be constructed as shown in principle the Proposed Block Plan, drawing no. 3556:02 Revision D, and provided with an appropriate dropped kerb crossing of the footway/verge. The construction works shall be regulated by an appropriate legal agreement with the Highway Authority, which will provide for but not be limited to the following:

i. A footway transition into the site on the south side of the vehicular access, connecting to the existing Medway Close footway.

ii. Clear to ground vehicular visibility splays of 2.4 metres x 43 metres in both directions, to be maintained in perpetuity.

iii. Provision of Traffic Regulation Order (TRO) parking restrictions to facilitate refuse vehicle entry to the development, prevent parking on the Medway Close to each side of the vehicular access to the north and the south and opposite the vehicular access on the east side of Medway Close, details to be agreed with and at no cost to the Highway Authority.

iv. Provision of all signing and lining in association with the highway works.

Reason: To provide appropriate footway connection, adequate inter-visibility between vehicles using the road junction and those in the existing public highway and to facilitate entry/exit of refuse vehicles, in the interest of highway safety in accordance with policy DM1.

3. There shall be no discharge of surface water from the development onto the Highway.

Reason: To prevent hazards caused by water flowing onto the highway and to avoid the formation of ice on the highway in the interest of highway safety to ensure accordance with policy DM1.

4. No unbound material shall be used in the surface treatment of the vehicular access within 6 metres of the highway boundary.

Reason: To avoid displacement of loose material onto the highway in the interests of highway safety in accordance with policy DM1.

5. Prior to first occupation of the development the vehicular area turning facility, shown in the Proposed Block Plan, drawing no. 3556:02 Revision D shall be constructed, surfaced and maintained free from obstruction within the site at all times for that sole purpose.

Reason: To ensure that vehicles can enter and leave the highway in a forward gear in the interest of highway safety in accordance with policy DM1.

6. Prior to first occupation of the proposed development, the 14no. vehicle parking spaces for the proposal,

shown in the Proposed Block Plan, drawing no. 3556:02 Revision D, including the garage parking and the 3no. unallocated visitor parking spaces, shall be constructed and appropriately surfaced ready for use in accordance with the Parking Standards. The vehicle parking area and associated turning area shall be retained in this form at all times. The vehicle parking shall not be used for any purpose other than the parking of vehicles.

Reason: To ensure that on street parking of vehicles in the adjoining streets does not occur in the interests of highway safety and that appropriate parking is provided in accordance with Policy DM8.

7. Prior to first occupation, the 2no. replacement garages labelled G1 and G2, shown in the Proposed Block Plan, drawing no. 3556:02 Revision D, shall be constructed ready for use.

Reason: To ensure that on street parking of vehicles in the adjoining streets does not occur in the interests of highway safety and that appropriate parking is provided in accordance with Policy DM8.

8. Cycle parking shall be provided in accordance with the EPOA Parking Standards. The approved facility shall be secure, convenient, covered and provided prior to occupation and retained at all times.

Reason: To ensure appropriate cycle parking is provided in the interest of highway safety and amenity in accordance with Policy DM8.

9. Prior to occupation of the proposed development, the Developer shall be responsible for the provision and implementation of a Residential Travel Information Pack per dwelling, for sustainable transport, approved by Essex County Council, to include six one day travel vouchers for use with the relevant local public transport operator.

Reason: In the interests of reducing the need to travel by car and promoting sustainable development and transport in accordance with policies DM9 and DM10.

#### General

I. Prior to any works taking place in public highway or areas to become public highway the developer shall enter into an appropriate agreement with the Highway Authority to regulate construction works. This will include the submission of detailed engineering drawings for approval and a safety audit.

II. The above to be provided at no cost to the Highway Authority

III. The above to be imposed on the planning permission (if granted) by planning obligation or condition, as necessary.

The above conditions are to ensure that the proposal conforms to the relevant policies contained within the

County Highway Authority's Development Management Policies, adopted as County Council Supplementary Guidance in February 2011.

Please include the informatives:

i. All work within or affecting the highway is to be laid out and constructed by prior arrangement with, and to the requirements and satisfaction of, the Highway Authority, details to be agreed before the commencement of works:

The applicants should be advised to contact the Development Management Team by email at [development.management@essexhighways.org](mailto:development.management@essexhighways.org)

ii. All housing developments in Essex which would result in the creation of a new street (more than five dwelling units communally served by a single all-purpose access) will be subject to The Advance Payments Code, Highways Act, 1980. The Developer will be served with an appropriate Notice within 6 weeks of building regulations approval being granted and prior to the commencement of any development must provide guaranteed deposits which will ensure that the new street is constructed in accordance with acceptable specification sufficient to ensure future maintenance as a public highway.

iii. Mitigating and adapting to a changing climate is a national and Essex County Council priority. The Climate Change Act 2008 (amended in 2019) commits the UK to achieving net-zero by 2050. In Essex, the Essex Climate Action Commission proposed 160+ recommendations for climate action. Essex County Council is working with partners to achieve specific goals by 2030, including net zero carbon development. All those active in the development sector should have regard to these goals and applicants are invited to sign up to the Essex Developers' Group Climate Charter [2022] and to view the advice contained in the Essex Design Guide. Climate Action Advice guides for residents, businesses and schools are also available.

## Recycling & Waste Collection Services

Comments

09.03.2023 - I have concerns in relation to vehicles accessing the site, the vehicles would need to swing into the site which due to cars parked directly opposite the entrance they would not be able to do.

I have concerns that the turning head as shown would not allow vehicles to easily position themselves to be able to reverse past the front of the properties, this would only be made more difficult/impossible if vehicles were parked in the turning head which often happens.

My comments have taken into consideration the tracked drawing.

## Essex County Council (SUDS)

### Comments

19.07.2023 - Consultation Response -23/00195/FUL- Garages Rear Of 27 Medway Close Chelmsford Essex

Thank you for your email which provides Essex County Council (ECC) with the opportunity to assess and advise on the proposed surface water drainage strategy for the aforementioned planning application.

As the Lead Local Flood Authority (LLFA) ECC provides advice on SuDS schemes for major developments. ECC have been statutory consultee on surface water since the 15th April 2015.

In providing advice this Council, and their appointed consultants, looks to ensure sustainable drainage proposals comply with the required standards as set out in the following documents:

- o Non-statutory technical standards for sustainable drainage systems
- o Essex County Council's (ECC's) adopted Sustainable Drainage Systems Design Guide
- o The CIRIA SuDS Manual (C753)
- o BS8582 Code of practice for surface water management for development sites.

#### Lead Local Flood Authority position

As we have been consulted on a minor application, we are assuming that there is a potential flood risk on site, therefore we are considering the impact of increased run off rates. The cumulative impacts of minor developments can increase flood risk in an area.

This site is located within the NCLF\_001 St Andrews South Critical Drainage Area (CDA).

Current processes for assessing major applications cannot be applied in the same way to minor applications as reduced orifice sizing to meet the greenfield 1 in 1 rate can increase the risk of blockages and therefore flood risk.

The required storage volume and run off for the site can be calculated using the UK SUDS website.

Having reviewed the application we wish to issue a holding objection based upon the following:

- o Discharge should be in line with the drainage hierarchy. Figure 3.3 shows that there is both a main river and a known watercourse to the west of the site. If this is an unviable discharge option, please evidence

why.

<https://www.essexdesignguide.co.uk/suds/discharge-locations/the-drainage-hierarchy/>

o Infiltration testing/ground investigation to assess the viability of using infiltration on site- there should be some ground testing for geology and then the worst case rates for that soil type should be used.

o As the site is situated within a CDA, rainwater harvesting should be considered. At a minimum, each dwelling should be fitted with a water butt.

o Please provide hydraulic modelling for the 1-year storm event. Sewer Network Design should demonstrate that there is No Surcharging for the 1 in 1yr RP.

o Engineering drawings should be provided detailing the SuDS components used within the drainage system.

We strongly recommend looking at the Essex Green Infrastructure Strategy to ensure that the proposals are implementing multifunctional green/blue features effectively. The link can be found below.

<https://www.essex.gov.uk/protecting-environment>

We recommend that a covenant should be included within the deed to the land to ensure SUDS features are maintained in the future.

Should you wish us to provide further comment additional information should be supplied to show how SUDS will be implemented on site.

#### Summary of Flood Risk Responsibilities for your Council

We have not considered the following issues as part of this planning application as they are not within our direct remit; nevertheless these are all very important considerations for managing flood risk for this development, and determining the safety and acceptability of the proposal. Prior to deciding this application you should give due consideration to the issue(s) below. It may be that you need to consult relevant experts outside your planning team.

o Sequential Test in relation to fluvial flood risk;

o Safety of people (including the provision and adequacy of an emergency plan, temporary refuge and rescue or evacuation arrangements);

o Safety of the building;

o Flood recovery measures (including flood proofing and other building level resistance and resilience measures);

o Sustainability of the development.

In all circumstances where warning and emergency response is fundamental to managing flood risk, ECC advise local planning authorities to formally consider the emergency planning and rescue implications of new development in making their decisions.

Should further correspondence be required, please contact the SuDS team directly using the below details.

17.08.2023 - Dear Joshua,

Following receipt of a revised FRA which you were cc'd into (also attached above), SuDS are satisfied with the information provided to remove the holding objection on this minor application.

Please may the updated FRA be uploaded to the planning portal, as well as the attached email as it mentions water butts, which SuDS would expect to see for developments located within critical drainage areas.

Kind regards,

Gemma

Gemma Parson (she, her)

Development and Flood Risk Officer

Climate Adaptation and Mitigation, Climate, Environment & Customer Services

17.08.2023 - Consultation Response -23/00195/FUL- Garages Rear Of 27 Medway Close, Chelmsford, Essex

Thank you for your email which provides Essex County Council (ECC) with the opportunity to assess and advise on the proposed surface water drainage strategy for the aforementioned planning application.

As the Lead Local Flood Authority (LLFA) ECC provides advice on SuDS schemes for major developments. ECC have been statutory consultee on surface water since the 15th April 2015.



In providing advice this Council, and their appointed consultants, looks to ensure sustainable drainage proposals comply with the required standards as set out in the following documents:

- o Non-statutory technical standards for sustainable drainage systems
- o Essex County Council's (ECC's) adopted Sustainable Drainage Systems Design Guide
- o The CIRIA SuDS Manual (C753)
- o BS8582 Code of practice for surface water management for development sites.

Lead Local Flood Authority position

As we have been consulted on a minor application, we are assuming that there is a potential flood risk on site, therefore we are considering the impact of increased run off rates. The cumulative impacts of minor developments can increase flood risk in an area.

This site is located within the NCLF\_001 St Andrews South Critical Drainage Area (CDA).

Current processes for assessing major applications cannot be applied in the same way to minor applications as reduced orifice sizing to meet the greenfield 1 in 1 rate can increase the risk of blockages and therefore flood risk.

The required storage volume and run off for the site can be calculated using the UK SUDS website.

Having reviewed the application, we do not object to the granting of planning permission.

It has been confirmed that each dwelling will be fitted with a rainwater butt for rainwater re-use.

We strongly recommend looking at the Essex Green Infrastructure Strategy to ensure that the proposals are implementing multifunctional green/blue features effectively. The link can be found below.

<https://www.essex.gov.uk/protecting-environment>

We recommend that a covenant should be included within the deed to the land to ensure SUDS features are maintained in the future.

#### Summary of Flood Risk Responsibilities for your Council

We have not considered the following issues as part of this planning application as they are not within our direct remit; nevertheless these are all very important considerations for managing flood risk for this development, and determining the safety and acceptability of the proposal. Prior to deciding this application you should give due consideration to the issue(s) below. It may be that you need to consult relevant experts outside your planning team.

- o Sequential Test in relation to fluvial flood risk;
- o Safety of people (including the provision and adequacy of an emergency plan, temporary refuge and rescue or evacuation arrangements);
- o Safety of the building;
- o Flood recovery measures (including flood proofing and other building level resistance and resilience measures);
- o Sustainability of the development.

In all circumstances where warning and emergency response is fundamental to managing flood risk, ECC advise local planning authorities to formally consider the emergency planning and rescue implications of new development in making their decisions.

Should further correspondence be required, please contact the SuDS team directly using the below details.

Yours sincerely,

Gemma Parson

Development and Flood Risk Officer

Team: Green Infrastructure and Sustainable Drainage

Service: Climate Action and Mitigation

Essex County Council

Internet: [www.essex.gov.uk](http://www.essex.gov.uk)

Email: [suds@essex.gov.uk](mailto:suds@essex.gov.uk)

## Environment Agency

Comments

No response received

## ECC Historic Environment Branch

Comments

14.03.2023 - RE: 23/00195/FUL -

Demolition of existing garaging and redevelopment to provide 6 new affordable homes with associated access improvements, parking, private amenity space and landscaping.

Garages Rear Of 27 Medway Close, Chelmsford

The above application has been identified on the weekly list by the Historic Environment Advisor to Chelmsford City Council as having archaeological implications.

The Essex Historic Environment Record (EHER) shows that the proposed development is in an area with the potential for archaeological remains. From the area surrounding the proposed development multiple Roman coins have been recovered, including one from the site itself or its immediate environs (EHER 802) and two from further north (EHER 814). A flint arrowhead (EHER 81) and medieval pottery (EHER 825) have also been recovered from nearby.

Additionally, to the west of the site a series of cropmarks have been identified from aerial photography that have been interpreted as showing ring-ditches (some with central pits) and linear features (EHER 856).

Archaeological features or deposits relating to the remains described above may project into the proposed development site and be negatively impacted by the groundworks associated with the development.

Given the above, this office recommends that the following conditions are placed on any consent, in line with the National Planning Policy Framework, paragraph 205:

RECOMMENDATION: Archaeological trial-trenching and excavation

(i) No development or preliminary groundworks of any kind shall take place until a programme of archaeological investigation has been secured in accordance with a Written Scheme of Investigation which has been submitted by the applicant, and approved in writing by the local planning authority.

(ii) No development or preliminary groundworks of any kind shall take place until the completion of the programme of archaeological investigation identified in the Written Scheme of Investigation defined in (i) above.

(iii) The applicant will submit to the local planning authority a post excavation assessment (to be submitted within six months of the completion of the fieldwork, unless otherwise agreed in advance with the Planning Authority). This will result in the completion of post excavation analysis, preparation of a full site archive and report ready for deposition at the local museum, and submission of a publication report.

The work will comprise an archaeological trial-trenching evaluation of the proposed development site, after the demolition of the garages to ground-level only. Depending on the results of this evaluation, it may then be followed by excavation areas focused on any archaeological deposits identified, and/or monitoring of groundworks associated with the development.

An archaeological brief will be produced from this office detailing the work required, on request, and should be acquired prior to the submission of a Written Scheme of Investigation.

If you have any questions please do not hesitate to contact me.

Yours sincerely,

## Local Residents

### Comments

Local residents: 14 letters of representation (including an unsigned petition) received from local residents all objecting to the proposed development. Concerns raised include:

- Environmental and ecological impacts.
- Increase in noise intrusion.
- Access and safety issues.
- Inadequate parking levels to serve the wider housing estate.
- Harmful to privacy of adjacent neighbouring properties.
- Not in accordance with Development Standards in Appendix B of Chelmsford Local Plan.
- Visual intrusion of development.

- Block light to neighbouring properties.
- Flood risk from surface water.
- Contamination issues.
- Inadequate parking provision.



0 12.5 25 50 Metres

1:1,250



**Planning Committee**  
**23/00195/FUL**

**Planning & Development Management**  
**Directorate for Sustainable Communities**

PO Box 7544 Civic Centre  
Duke Street, Chelmsford, CM1 1XP

Based upon the Ordnance Survey mapping with the permission of the Controller of Her Majesty's Stationary Office. Crown copyright.  
Unauthorised reproduction infringes Crown copyright and may lead to prosecution or civil proceedings

Chelmsford City Council Licence Number 100023562 2023.

Telephone: 01245 606826

This drawing is copyright © and must not be reproduced in whole or part without obtaining written authority from John Finch Partnership.  
Do not scale from this drawing.  
All dimensions to be checked on site.  
Refer any discrepancies to the project Architect.

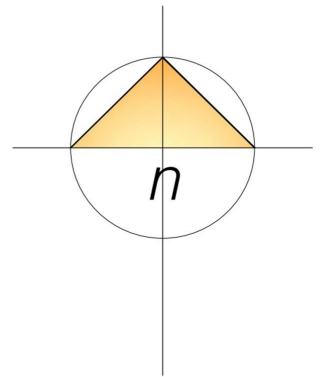

# Location plan

A4 SHEET @ 1:1250

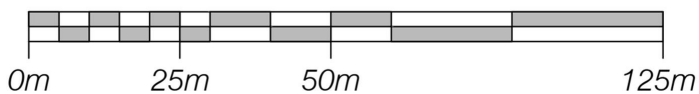

revision

issue

PLANNING

client

Chelmsford City Council

project

Medway Close, Chelmsford

title

Location Plan

**john finch partnership**  
chartered architects & town planning consultants



88 Broomfield Road  
Chelmsford CM1 1SS  
01245 354319/250780  
admin@johnfinchpartnership.co.uk

www.johnfinchpartnership.co.uk

date 08.11.22 scale 1:1250 @ A4

drawn jm/jh checked jm

dwg no 3556:01 revision E

A3 SHEET @ 1:500

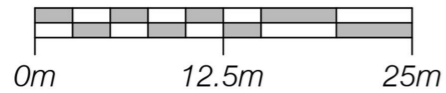

This drawing is copyright © and must not be reproduced in whole or part without obtaining written authority from John Finch Partnership. Do not scale from this drawing. All dimensions to be checked on site. Refer any discrepancies to the project Architect.



**Accommodation Schedule**

Plot No.	Accommodation	Area (m <sup>2</sup> )	Amenity (m <sup>2</sup> )
01	4 Bedroom 6 person house	110	108
02	4 Bedroom 6 person house	110	104
03	4 Bedroom 6 person house	110	104
04	4 Bedroom 6 person house	110	104
05	4 Bedroom 6 person house	110	110
06	1 Bedroom 2 person apartment	60	4
G1/2	Private Double Garage	42	

Key:  
(See in conjunction with submitted landscaping proposal plan 2022.51.004)

- Retained Tree
- Proposed Tree
- Permeable standing
- Permeable pavers
- Cycle Stores
- Bins
- 1800mm h. close boarded timber fence
- 1800mm h. 225mm thick external brick wall

revision

issue

PLANNING

client

Chelmsford City Council

project

Medway Close, Chelmsford

title

Proposed Block Plan

**john finch partnership**  
chartered architects & town planning consultants



88 Broomfield Road  
Chelmsford CM1 1SS  
01245 354319/250780  
admin@johnfinchpartnership.co.uk

www.johnfinchpartnership.co.uk

date 17.03.2023 scale 1:500 @ A3

drawn jm/jh checked jm

dwg no 3556:02 revision G

Site Area= 0.23ha

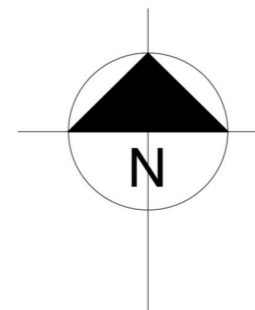



**LANDSCAPE SPECIFICATION:**

All landscape works to be carried out broadly in accordance with the relevant current British Standards; National Planting Specifications Guidelines; Horticultural Trades Association Standards; CPSE Plant Handling Standards & COSHH Regulations.

**TOPSOIL**

**Importation:**  
 • Provide as necessary to make up any deficiency of topsoil existing on site and to complete the work. Any imported soil should be to BS 3882.

**Handling:**

- Ensure that any aggressive weeds are removed from site – do not cut or distribute.
- Select and use plant to minimize disturbance, trafficking and compaction.
- Do not contaminate topsoil with subsoil, stone, hardcore, rubbish or material from building works.
- Alleviate any compaction of the soil prior to planting or turfing and do not handle topsoil in wet conditions or after heavy rainfall.

**PLANTING**

**Seeding & Turfing:**  
 • Ensure that there is a healthy, vigorous grass sward, free from the visible effects of pests, weeds and disease.  
 • The final sward should form a closely knit, continuous ground cover of even density, height and colour.

**Watering:**

• As and when required to ensure healthy establishment of plants.

**Site Clearance:**

• Remove rubbish, concrete, metal, glass, decayed vegetation and contaminated topsoil.

**Soil Conditions:**

• Soil for cultivating and planting must be moist, friable and not waterlogged.  
 • No planting to take place if soil is frozen or snow covered and any plants waiting to be planted should be given additional root protection.  
 • Prevent planting pit sides and bases and backfill materials from freezing.

**Plants:**

• Plant names, forms, dimensions and other criteria: To be labelled as per the applicable section of BS 3936.  
 • Frost: Protect plants from frost and handle plants with care. Protect from mechanical damage and do not subject to shock, e.g. by dropping from a vehicle.  
 • Planting: Upright or well balanced with best side to front, well firmed in and evenly spaced.  
 • Ornamental trees within the to be staked with a single low stake at 45degrees to the stem and tied with an adjustable rubber tie.

**Timing:**

• The landscape scheme/planting programme is confirmed as being timetabled for implementation by or during the first planting season (mid-November to mid-March) following commencement of works.

**Cultivation:**

• Compacted topsoil to be broken up to full depth. Cultivate, aerate and break up soil a few days before planting when weather and ground conditions are suitably dry, leaving the surface regular and even.  
 • Any undesirable material brought to the surface including visible weeds, roots and large stones to be removed.

**Weeding of planted areas:**

• All areas to be checked regularly and kept free of invasive weeds. Either remove by hand (root included) or spot treated with a non-residual herbicide in accordance with the Manufacturer's instructions.

**Mulching:**

• Well-rotted bark mulch, free of pests, disease, fungus and weeds to be applied 100mm thick to be applied to all planting areas.

**Spot treatment of weeds:**

• Weeding of planted areas to be undertaken on a regular basis to ensure that the plants are given a fair chance to establish. Care to be taken to ensure that invasive and aggressive weeds do not become a problem and impact on the overall planting scheme. Where necessary, spot treatment of weeds in planted and grassed areas would be undertaken to ensure that they do not seed and establish elsewhere.  
 • Regular tidying of the planting beds – including:  
 - removal of leaf litter and any other debris  
 - shrubs and trees to be regularly pruned in order to maintain healthy growth and vigour.  
 - Any dead, diseased or dying trees or shrubs to be taken away or affected limbs removed.

**MANAGEMENT**

**Protection of existing vegetation:**

• There are a number of hedges on the peripheries of the site and where possible, existing vegetation would be retained. Protection of trees and hedges would be in accordance with BS 5837: 2012 Trees in relation to design, demolition and construction. n should be taken when working adjacent to the existing trees and hedges, particularly in relation to the washing out of machines, storage of materials and other activities which may be deemed hazardous to the health and well being of the existing vegetation.

**Inspection Timetable:**

• The planting will be subject to an annual inspection each summer for the first 5 years to ensure that any dead, dying or diseased plants are removed. Those removed will be replaced with the same size or species as per the planting specification. Management of the overall scheme will incorporate regular reviews to check that the scheme is establishing well and any concerns highlighted and an appropriate professional consulted in order to address any issues.

**PLANT SCHEDULE**

**SHRUBS**

QTY	CODE	PLANT NAME	STOCK	SIZE	SPACING
15No.	Lon BG	Lonicera nitida 'Boggensens Gold'	C 3L	30-40cm	3/m2

**TREES**

QTY	CODE	PLANT NAME	STOCK	FORM	GIRTH/HEIGHT
6No.	CRA MON hs	Crataegus monogyna	B	STD	12-14cm
5No.	MAL Eve f	Malus 'Evereste'	c	FTH	150-200cm
4No.	MAL SYL s	Malus sylvestris	B	STD	180-210cm
2No.	PRU PLE ss	Prunus avium 'Piena'	B	STD	10-12cm
1No.	SOR STR ss	Sorbus aucuparia 'Streetwise'	B	STD	10-12cm

**PLANT MIXES**

PERCENT	QTY	PLANT NAME	STOCK	SIZE
31m2 GROUND COVER MIX 4 planted @ 3/m2				
20%	19No.	Lonicera pileata	C 2L	20-30cm
20%	19No.	Rosa grouse	C 2L	20-30cm
15%	14No.	Euonymus fortunei 'Coloratus'	C 2L	20-30cm
15%	14No.	Coloneaster horizontalis	C 2L	20-30cm
15%	14No.	Rosa 'Max Graf'	C 2L	20-30cm
15%	14No.	Ceanothus thysiflorus 'Repens'	C 2L	20-30cm

PERCENT	QTY	PLANT NAME	STOCK	SIZE
14m2 SOUTH FACING SHRUB MIX planted @ 4/m2				
15%	10No.	Hebe 'Caedonic'	C 2L	10-20cm
25%	16No.	Lavendula angustifolia 'Hidcote'	C 2L	10-20cm
10%	6No.	Euonymus fortunei 'Emerald Gaiety'	C 2L	20-30cm
25%	16No.	Geranium sanguineum 'Album'	C 2L	10-20cm
25%	16No.	Ceanothus thysiflorus var. repens	C 2L	20-30cm

30m2 EAST FACING SHRUB MIX planted @ 3/m2  
 15% 14No. Pachysandra terminalis C 3L 40-60cm  
 25% 23No. Spirea japonica 'Goldflame' C 3L 40-60cm  
 10% 9No. Euonymus fortunei 'Emerald Gaiety' C 3L 40-60cm  
 25% 23No. Viburnum linaus 'Eve Price' C 3L 40-60cm  
 25% 23No. Pittosporum 'Toms Thumb' C 3L 40-60cm  
 Individual varieties to be planted in groups of approximately 3, 5 or 7.

**NOTES AND ABBREVIATIONS:**

B = Bare root (bagged).  
 C = Container (or pot) grown, followed by size of the container (or pot).  
 FORM = Shape of tree as supplied by the nursery.  
 FTH = Feather.  
 QTY = Quantity  
 SIZE = Height or Spread of juvenile plant.  
 STD = (clear stem) Standard.  
 STOCK = Root condition/protection method eg Bare root.

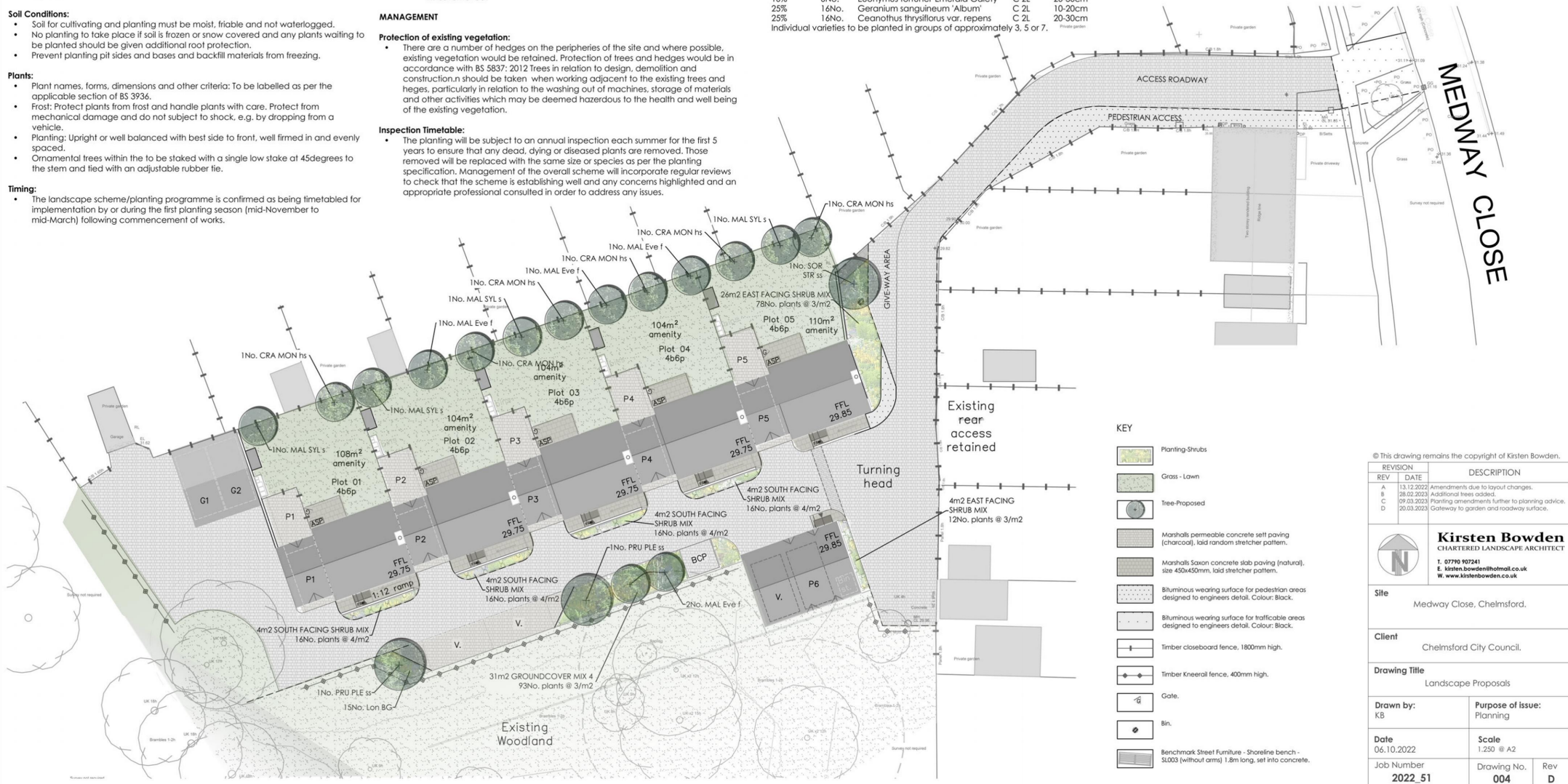



Front Elevation  
Plots 01-05



Rear Elevation  
Plots 01-05

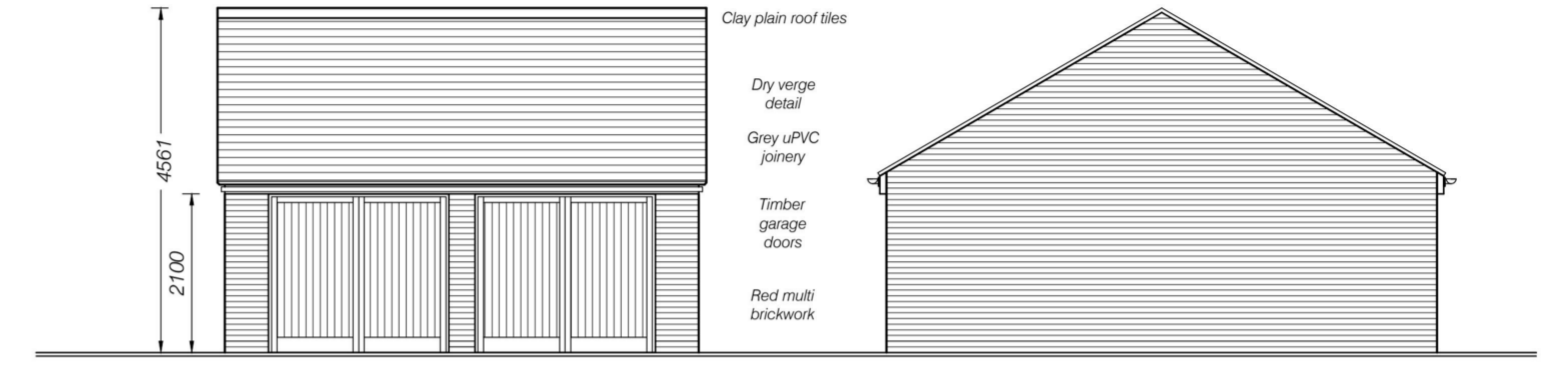

Garage front elevation

Side elevation

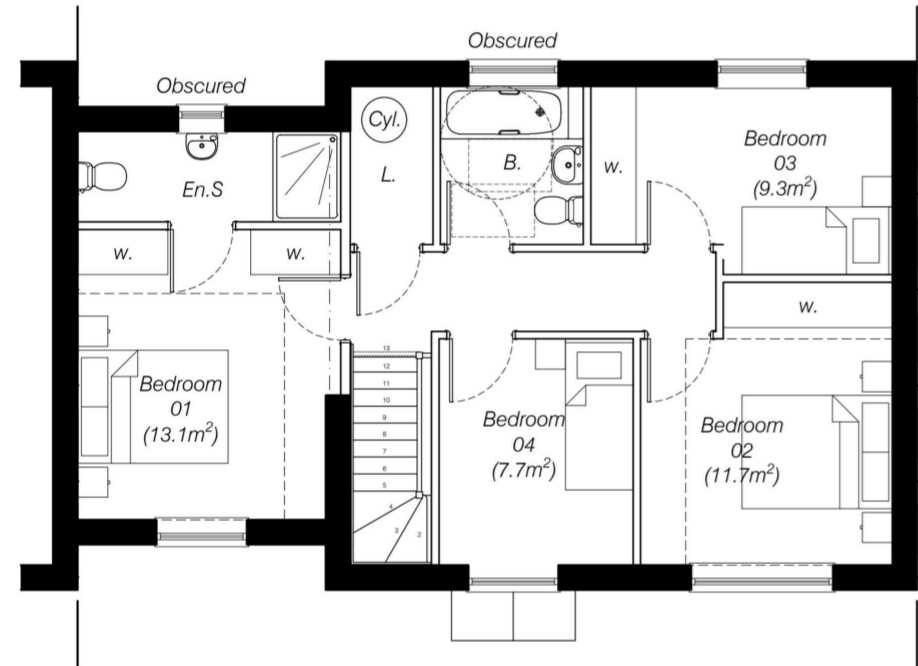

First Floor

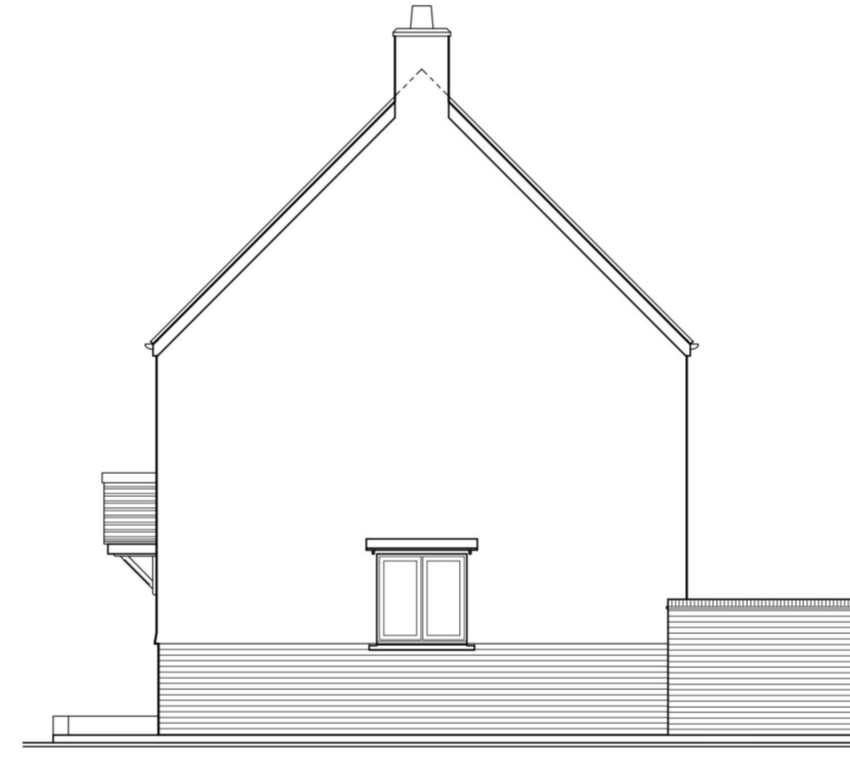

Side Elevation Plot 5

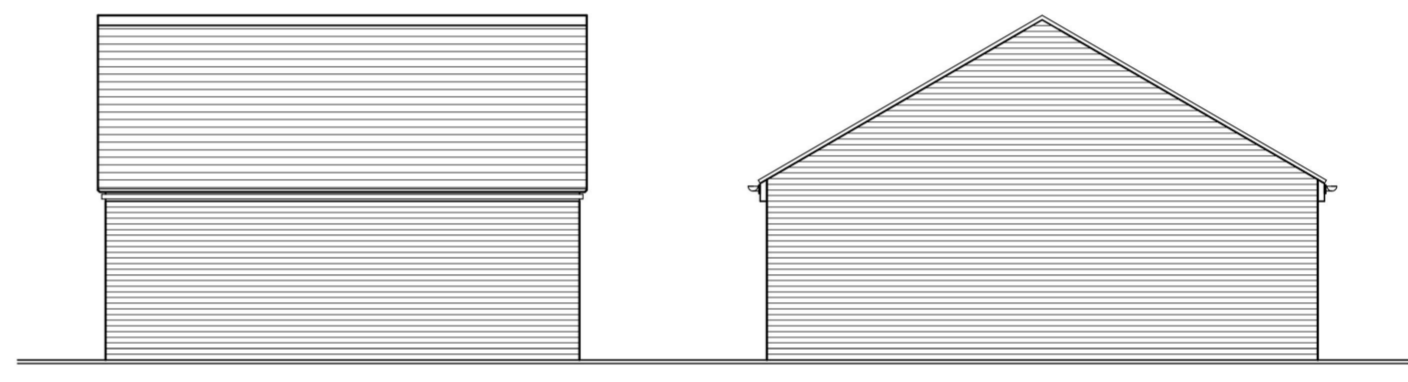

Rear elevation

Side elevation

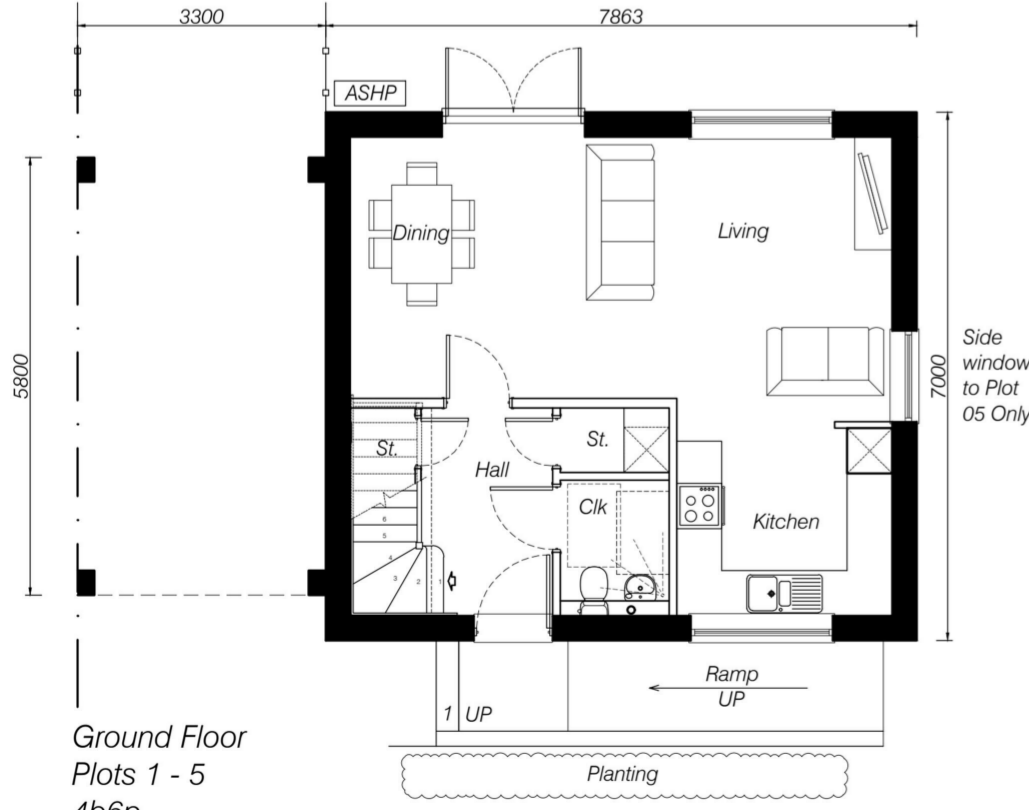

Ground Floor  
Plots 1 - 5  
4b6p  
110m² total GIA

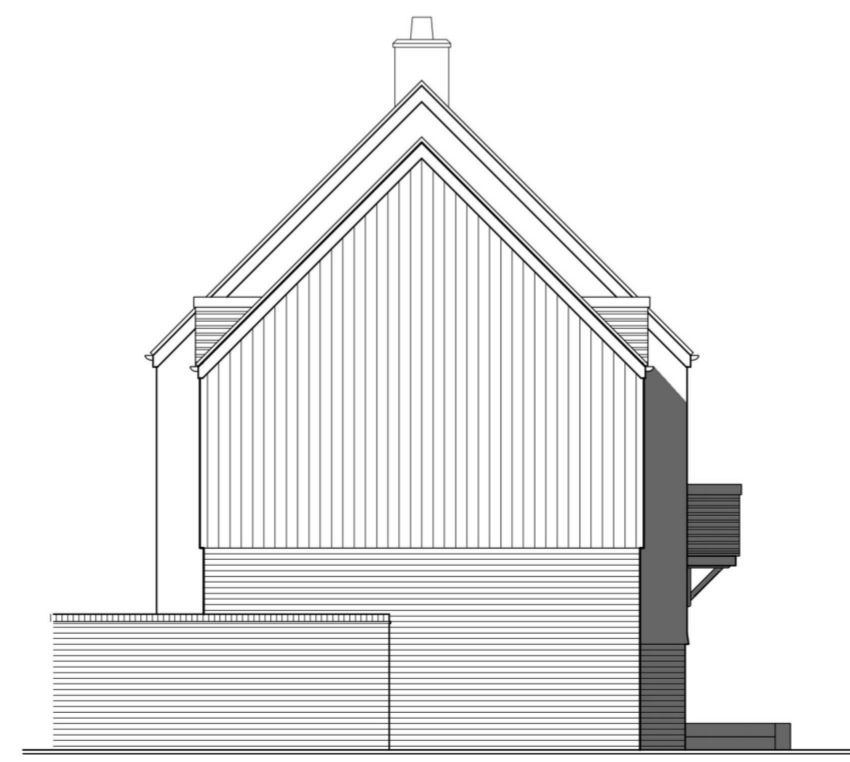

Side Elevation Plot 1

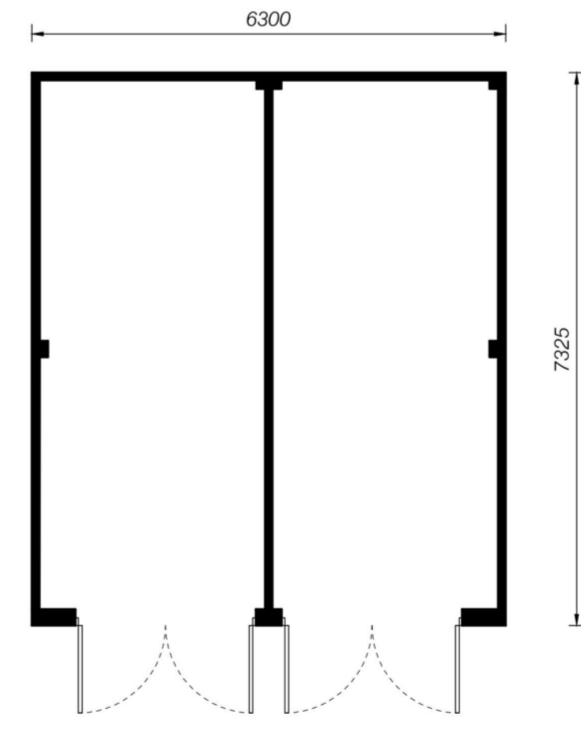

G1/2 Garage Floor Plan

revision	
issue	PLANNING
client	Chelmsford City Council
project	Medway Close, Chelmsford
title	Plots 1-5 Proposed Plans, Elevations & Garage
<b>john finch partnership</b> chartered architects & town planning consultants	



88 Broomfield Road  
Chelmsford CM1 1SS  
01245 354319/250780  
admin@johnfinchpartnership.co.uk

www.johnfinchpartnership.co.uk

date	15.03.2023	scale	1:100 @ A2
drawn	jm/jh	checked	jm
dwg no	3556:03	revision	H

A2 SHEET @ 1:100

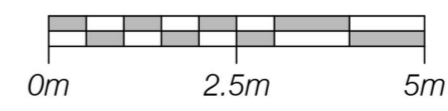

M4(2) Accessible and Adaptable dwelling

A3 SHEET @ 1:200

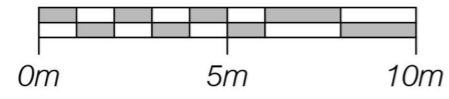

Street Scene

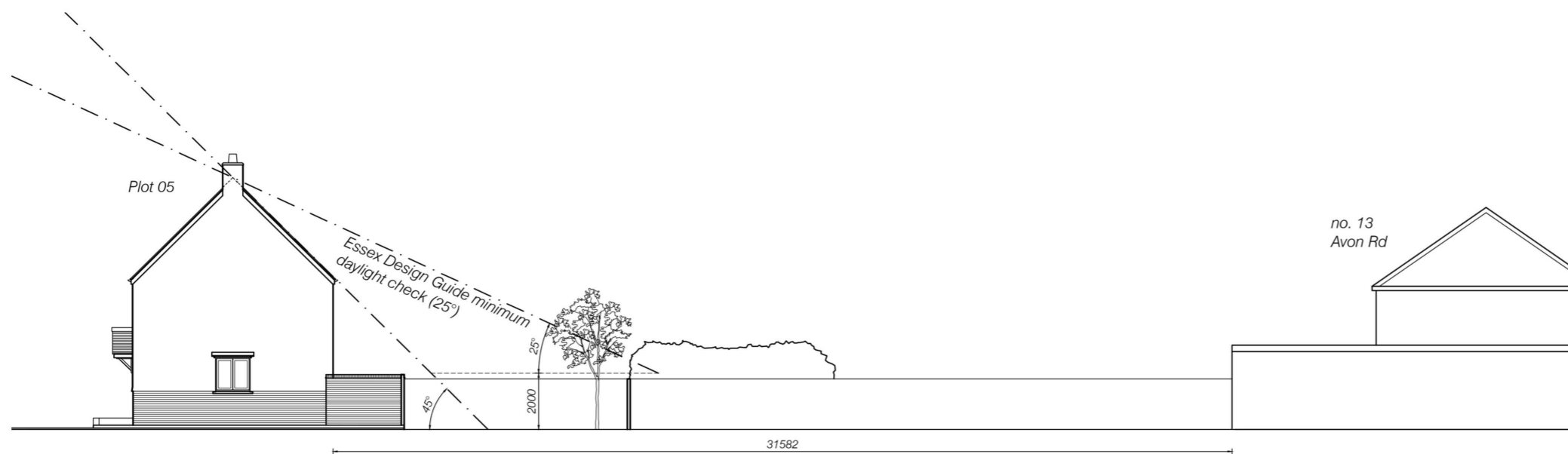

Section through site:  
Plot 05 to no.13 Avon Rd

revision

issue

PLANNING

client

Chelmsford City Council

project

Medway Close, Chelmsford

title

Proposed Street Scene  
and Site Section

**john finch partnership**  
chartered architects & town planning consultants



88 Broomfield Road  
Chelmsford CM1 1SS  
01245 354319/250780  
admin@johnfinchpartnership.co.uk

www.johnfinchpartnership.co.uk

date 21.03.2023 scale 1:200 @ A3

drawn jh checked jm

dwg no 3556:05 revision F



Front Elevation



Side Elevation

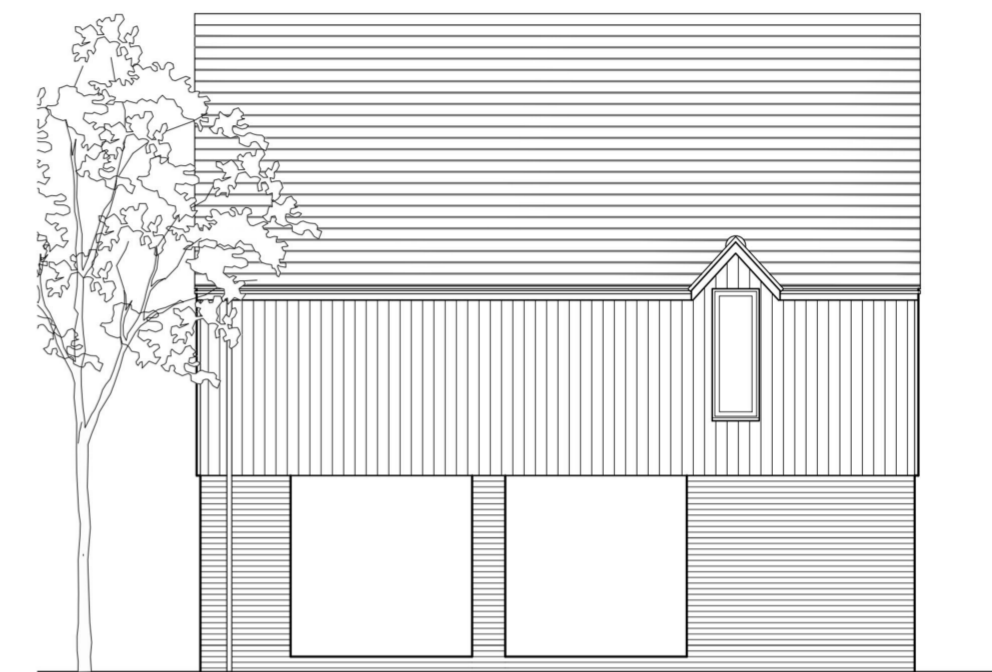

Rear Elevation

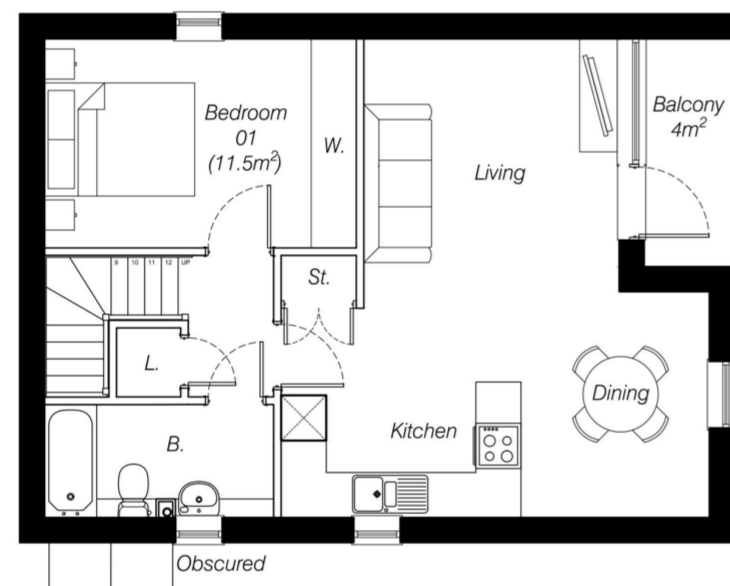

First Floor



Side Elevation

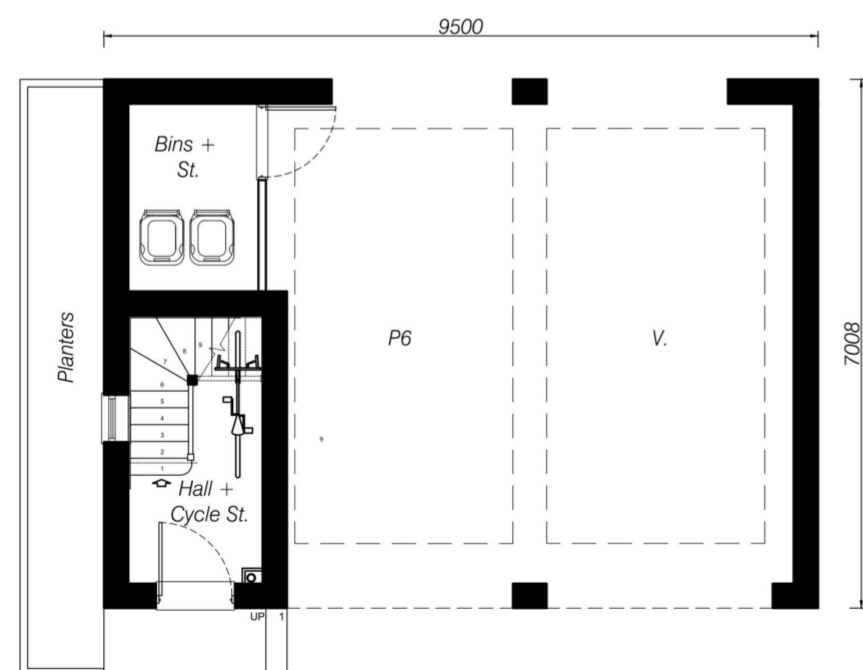

Ground Floor  
Plot 6  
1b2p  
56m2 total GIA

M4(1) Visitable dwelling

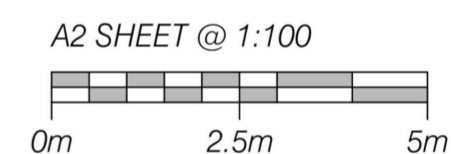

revision  
issue  
client

PLANNING

Chelmsford City Council

project  
Medway Close, Chelmsford

title  
Plot 6 Proposed Plans & Elevations

**john finch partnership**  
chartered architects & town planning consultants



88 Broomfield Road  
Chelmsford CM1 1SS  
01245 354319/250780  
admin@johnfinchpartnership.co.uk

www.johnfinchpartnership.co.uk

date	08.03.2023	scale	1:100 @ A2
drawn	jh	checked	jrm
dwg no	3556:04	revision	G



# Preliminary Ecological Appraisal

of

## Land at Medway Close, Chelmsford, Essex

on behalf of

**Chelmsford City Council**

**October 2022**

© James Blake Associates Ltd 2022

Over 30 Years of Service, Value and Innovation

34-52 Out Westgate, Bury St. Edmunds, Suffolk IP33 3PA  
tel: **01284 335797** email: [jamesblake@jba-landmarc.com](mailto:jamesblake@jba-landmarc.com)

**Chairman:** James Blake BA (Hons) Dip LA (Hons) CMLI

**Company Secretary:** Louise Blake BSc PGCE

**Directors:** Elzbieta Zebrowska MSc Eng LArch MScEnvSc CMLI

**Associate Directors:** Vivienne Jackson : Marie Lowe CIMA Cert BA

**Associate Director - Strategic Landscape Division:** Abby Stallwood BSc (Hons) PG Dip LM CMLI

[www.jba-landmarc.com](http://www.jba-landmarc.com)

Registration no. 08169866 VAT no. 512.4127 91

Revision	Purpose	Originated	Checked	Authorised	Date
		BFH	SR	JBA	October 2022
<b>Job Number:</b>  JBA 22/119		 <p><b>JAMES BLAKE</b> ASSOCIATES</p>			
		<b>Title:</b> Preliminary Ecological Appraisal of Land at Medway Close, Chelmsford, Essex			

### **Disclaimer**

*James Blake Associates Ltd have made every effort to meet the client's brief. However, no survey ensures complete and absolute assessment of the changeable natural environment. The findings in this report were based on evidence from thorough survey: It is important to remember that evidence can be limited, hard to detect or concealed by site use and disturbance. When it is stated that no evidence was found or was evident at that point in time, it does not mean that species are not present or could not be present at a later date: The survey was required because habitats are suitable for a given protected species, and such species could colonise areas following completion of the survey.*

*This report was instructed by Chelmsford City Council. Neither James Blake Associates Ltd nor any associated company, nor any of their employees, nor any of their contractors, subcontractors or their employees, makes any warranty, express or implied, or assumes any legal liability or responsibility for the accuracy, completeness, or any third party's use of the report.*

© **James Blake Associates Ltd 2022** (Copyright of this report remains with James Blake Associates Ltd: Content must not be reproduced, in whole or part, without formal written consent).

## CONTENTS

	<b>NON-TECHNICAL SUMMARY .....</b>	<b>4</b>
<b>1</b>	<b>BACKGROUND.....</b>	<b>5</b>
<b>2</b>	<b>METHODOLOGY.....</b>	<b>7</b>
<b>3</b>	<b>RESULTS .....</b>	<b>10</b>
<b>4</b>	<b>PROTECTED SPECIES – RESULTS AND EVALUATION.....</b>	<b>16</b>
<b>5</b>	<b>EVALUATION, LEGISLATION AND RECOMMENDATIONS.....</b>	<b>20</b>
<b>6</b>	<b>ECOLOGICAL ENHANCEMENTS .....</b>	<b>24</b>
<b>7</b>	<b>CONCLUSION .....</b>	<b>25</b>
<b>8</b>	<b>REFERENCES .....</b>	<b>26</b>
<b>9</b>	<b>BIBLIOGRAPHY.....</b>	<b>27</b>
<b>10</b>	<b>APPENDIX.....</b>	<b>28</b>
	<b>Appendix A: Statutory designated wildlife sites within 7km .....</b>	<b>28</b>
	<b>Appendix B: Non-statutory designated wildlife sites within 2km.....</b>	<b>28</b>
	<b>Appendix C: Flora list identified during the walkover survey .....</b>	<b>29</b>

## Non-technical Summary

<b>Site:</b>	Land at Medway Close, Chelmsford
Ordnance Survey National Grid Reference:	TL 68750 07623
Report Commissioned by:	Chelmsford City Council
Date of Walkover Survey:	26 <sup>th</sup> August 2022

Considerations	Description	Potential impacts and timing
Statutory designated wildlife areas within 7km of the site:	Three Local Nature Reserves (LNR) and one Site of Special Scientific Interest (SSSI)	Consultation with Natural England and the Local Planning Authority may be required with regards to the Suffolk Recreational Disturbance Avoidance and Mitigation Strategy.
Non-statutory designated wildlife sites within 2km of the site:	Severn County Wildlife Sites (CWS).	The small scale of the development is unlikely to cause a significant impact to non-statutory sites.
Results of walkover survey:	The site is considered suitable to support bats, great crested newt, hedgehog, and nesting birds. The site is considered to be of 'low' habitat value for foraging and commuting bats.	
Precautionary measures:	Any vegetation removal.	Under the supervision of a GCN licenced ecologist.  Outside of the nesting bird season or following a clear nesting bird check. Nesting season is March to mid-August.  Scrub should be cut to 20cm using hand-held tools and checked for hedgehogs.
	Continual management of grassland.	-
	Garage demolition.	Under ecological supervision.



## 1 Introduction

### Background

- 1.1 James Blake Associates Ltd. (JBA) was commissioned by Chelmsford City Council to undertake a Preliminary Ecological Appraisal (PEA) of land at Medway Close, Chelmsford. Ordnance Survey National Grid Reference; TL 68750 07623 taken from the centre of site.
- 1.2 The assessment was required to accompany a planning application for the development of residential dwelling units and associated infrastructure.

### Site Description

- 1.3 The site is approximately 0.2 hectares in size and is located to the north of Roxwell Road (A1060), on Medway Close, Chelmsford, in Essex. The wider landscape includes the town of Chelmsford, residential and commercial buildings, and arable land. The A414 is approximately 2.4km south of the site (see Figure 1 below).
- 1.4 The site itself mainly consists of hardground, two rows of abandoned, single-storey garages, with some vegetation in the form of tall ruderal and scrub to the north and south.

**Figure 1:** Site location

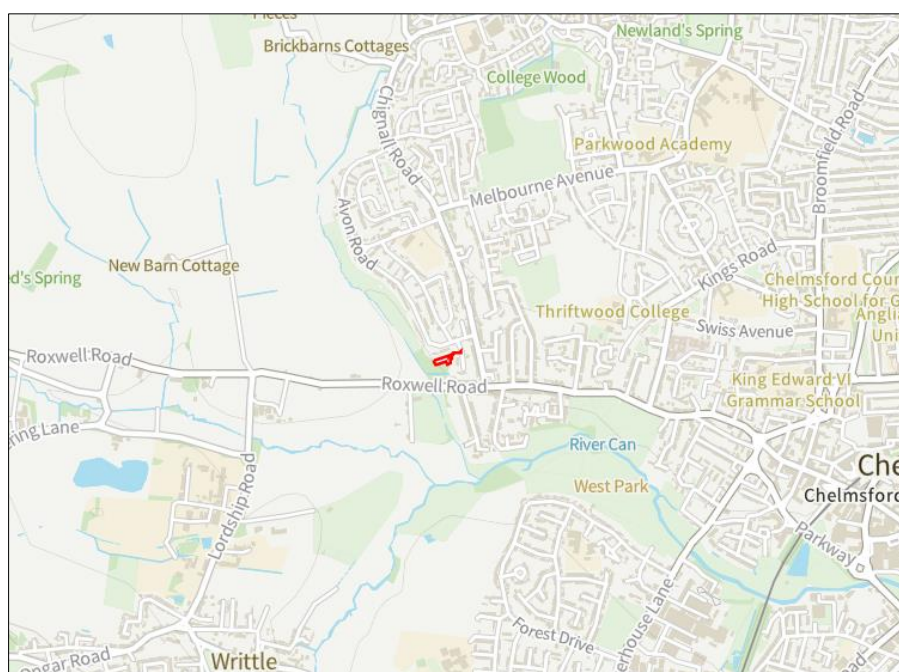

Reproduced from Magic maps data licence number 100059700

## **Aims and objectives**

1.5 The aim of the survey was to:

- Identify the presence, or potential presence, of any protected or notable species or habitats on, or adjacent to, the site; and
- make recommendations for further surveys if required, to advise on avoidance and/or mitigation measures following the survey (if necessary) and provide suggestions to enhance the wildlife value of the site post-development to provide a net gain in biodiversity value.

## **Wildlife Legislation and Planning Policy**

1.6 The relevant wildlife legislations and planning policies are listed below:

- Conservation of Habitats and Species Regulations 2017, ('The Habitats Regulations'). The Habitats Regulations implement The Habitats Directive 1992 (92/43/EEC) into English Law. (Amended by the Conservation of Habitats and Species (Amendment) Regulations 2012 S.I. 2012/1927).
- Wildlife and Countryside Act, 1981 (as amended) (WCA). (Amended by the Countryside and Rights of Way Act (2000).
- The Natural Environment and Rural Communities Act, 2006 (NERC).
- The Protection of Badgers Act, 1992 (The Badgers Act).
- The Wild Mammals (Protection) Act, 1996.
- The Hedgerows Regulations, 2007.
- National Planning Policy Framework, 2021 (NPPF).

## 2 Methodology

### *Desk study*

- 2.1 A desk study was undertaken for statutory and non-statutory designated wildlife sites within a 7km and 2km radius of the site, respectively using 'MAGIC', the Multi-Agency Geographic Information system for the Countryside. The data provided from Essex Field Club (EFC) was consulted for records of non-statutory sites and protected and rare species within a 2km search radius (EFC data provided on the 22<sup>nd</sup> August 2022).
- 2.2 The site is covered by the Local Biodiversity Action Plan (LBAP) for Essex which was consulted as part of the desk study.
- 2.3 Within the desk study results, the Birds of Conservation Concern (BoCC) are split into three criteria; the Red list is the highest conservation priority (species needing urgent action). The Amber list is the next most critical group, followed by Green. Red listed species are those that are globally threatened according to the International Union for Conservation of Nature (IUCN) criteria, species with populations or ranges that have declined rapidly in recent years, and those that have declined historically and have not shown a substantial recent recovery.

### *Walkover Survey*

- 2.4 The survey was undertaken by Bethan Feeney-Howell BSc (Hons) QCIEEM, and Sarah Jarrett BSc (Hons) MSc on the 26th of August 2022.
- 2.5 The survey methodology followed the standard Phase 1 methodology of Joint Nature Conservation Committee Guidelines (JNCC, 2010). An extension of this basic methodology was also undertaken to provide further details in relation to notable or protected habitats present within the survey area, or in relation to habitats present that have the potential to support notable or protected species (CIEEM, 2013).
- 2.6 **Badgers (*Meles meles*):** A visual survey for setts, hair, latrines, prints, snuffle marks or other signs of badgers was undertaken within the site boundary, following guidelines set out by the Mammal Society (1989).
- 2.7 **Bats:** Buildings within the site boundary were surveyed, from the ground, for their potential to support roosting bats in accordance with Bat Conservation Trust's Guidelines (Collins (ed.), 2016).
- 2.8 **Birds:** A visual survey of bird activity and suitable nesting habitat was carried out, to

determine if any areas would be suitable for WCA Schedule 1 birds, BoCC or other common and widespread nesting birds.

2.9 **Reptiles:** A visual survey for the presence of suitable habitat was carried out according to the criteria given in the Herpetofauna Workers' Manual (Gent and Gibson 1998).

2.10 **Amphibians:** Where accessible, known ponds within 500m of the site (unless ecologically separated from the site by significant barriers, such as major roads or rivers) were assessed for potential to support breeding amphibians, such as great crested newts (GCN) (*Triturus cristatus*). Ponds were assessed for their potential suitability to support GCN by undertaking a Habitat Suitability Index (HSI) assessment (Oldham *et al.*, 2000). The HSI for GCN is assessed using ten habitat variables (suitability indices – SI) which are known to affect the survival and ability to breed, of GCN. The variables include:

- Geographical location.
- Pond area.
- Pond permanence (number of years a pond is likely to dry out per decade).
- Water quality.
- Percentage of shade of margin.
- Number of waterfowl.
- Occurrence of fish.
- Pond density.
- Terrestrial habitat.
- Macrophyte (plant) cover.

Each variable (or suitability index) is assessed in the field and expressed on a scale from 1 (optimal suitability for GCN) to 0 (totally unsuitable). The ten variables, or indices, are combined using geometric mean to derive the final HSI score for the waterbody. The scoring system is presented in Table 1 below:

**Table 1:** HSI score and suitability of a waterbody habitat to support breeding GCN

HSI Score	Suitability of water body habitat to support breeding GCN
0.01-0.49	'Poor'
0.50-0.59	'Below average'
0.60-0.69	'Average'
0.70-0.79	'Good'

0.80-1.00	'Excellent'
-----------	-------------

- 2.11 **Invertebrates:** The site was scoped for significant rotting deadwood, and high quality aquatic or other habitats, which could be used by significant assemblages of invertebrates, or by any of the invertebrates highlighted in the data search.
- 2.12 **Flora and habitats:** All habitats and plant species that were identifiable at the time of the survey were recorded.
- 2.13 **Adjacent Habitat:** Habitats close to the site were identified, using aerial maps and field observation, so that the ecological impact of the proposed works on the wider landscape could be assessed.

#### *Limitations and Assumptions*

- 2.14 The baseline conditions reported in this document represent those identified at the time of the survey on 26<sup>th</sup> August 2022. Although a reasonable assessment of habitats present can be made during a single walkover survey, seasonal variations are not observed. The survey was conducted in August, which is within the optimal season for the identification of flora.
- 2.15 The desk study used available records and historical data from the local area. However, this does not provide a reliable indication of species present since records depend entirely on survey effort in the area, which is highly variable. The data is useful as a general guide to supplement the site visit, but absence of records does not reflect absence of species.

### 3 Results

#### Desk Study

##### *Statutory Designated Wildlife Sites*

- 3.1 Three 'Local Nature Reserve' (LNR) and one 'Sites of Special Scientific Interest' (SSSI) were identified within 7km of the site. Statutory designated sites are detailed in Appendix A.
- 3.2 The development falls under the criteria for consultation between Natural England and the Local Planning Authority (LPA); for new residential development in this area, financial contributions are required towards the emerging Essex Coast Recreational disturbance Avoidance and Mitigation Strategy (RAMS).

##### *Non-Statutory Designated Wildlife Sites*

- 3.3 There were seven non-statutory designated wildlife sites identified within 2km of the site; all of which are Local Wildlife Sites (CWS). These are detailed in Appendix B.
- 3.4 Due to the small scale of the proposed development, it is unlikely to cause any significant impacts to non-statutory designated wildlife sites.

##### *Ponds within 500m*

- 3.5 No ponds were identified within 500m of the site boundary; however, within the woodland directly west of the site, waterlogged conditions were noted (See Figure 2).

**Figure 2:** Waterlogged conditions in woodland

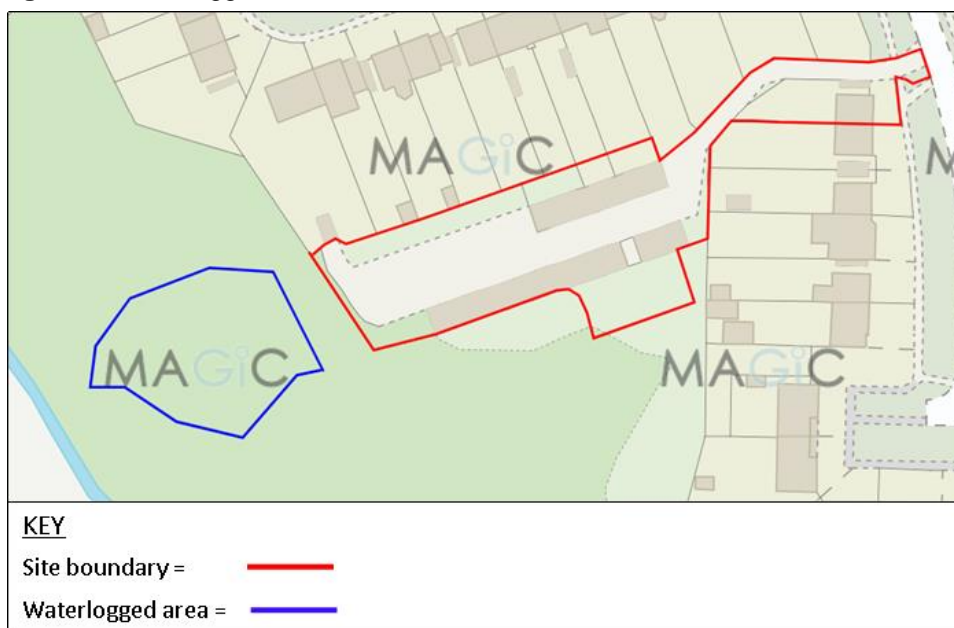

*Habitat Types within 2km*

3.6 Habitat types within the area include coastal and floodplain grazing marsh, good quality semi-improved grassland, ancient and semi-natural woodland, deciduous woodland, broadleaved, young trees, traditional orchards and woodpasture and parkland, Habitat types are shown on Figure 3. The nearest broadleaved and deciduous woodland is located directly adjacent the western boundary of the site, with woodpasture and parkland further south (686m).

**Figure 3:** Habitat types within 2km of the site

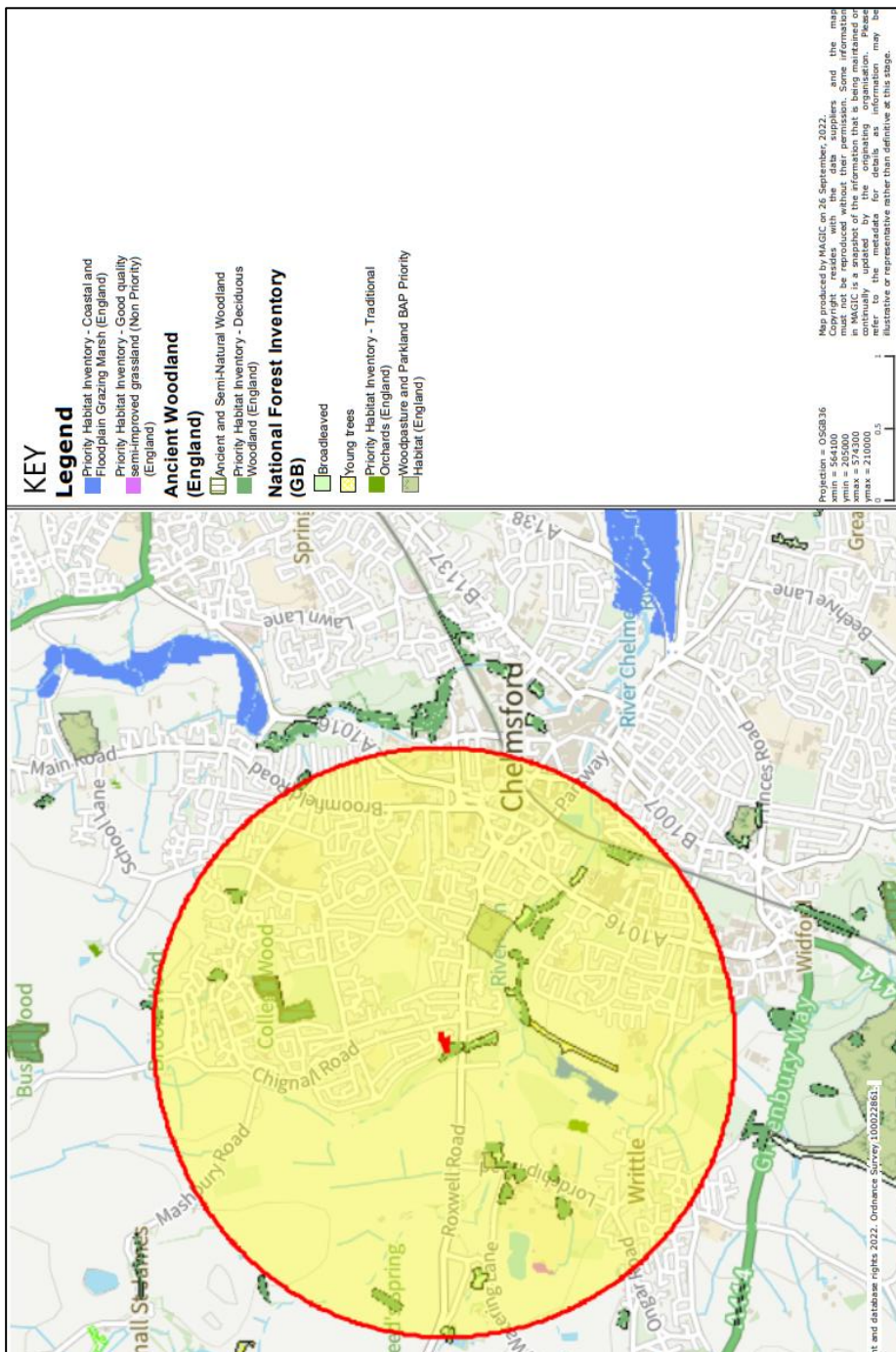

*Protected, priority and rare species within 2km of site*

- 3.6 There were no records of protected or rare species for the site itself; although there were numerous records of species within 2km of the site (full raw data can be provided upon request). The most relevant records are described below. Records over ten years old have not been referred to as the walkover survey is considered to provide a more up to date and accurate account of the species and habitats for the site.
- 3.7 European badger was recorded in 2019, within 2km of the site boundary.
- 3.8 Within the desk study common pipistrelle (*Pipistrellus pipistrellus*) were recorded in 2015, 1.1km east and in 2016, 1.8km southwest of the site. Soprano pipistrelle (*Pipistrellus pygmaeus*) were recorded just 0.5km southeast of the site in 2018. Brown long-eared bat (*Plecotus auritus*) were also recorded in the desk study, 1.7km southwest of the site in 2015.
- 3.9 Hedgehog (*Erinaceus europaeus*) has been recorded on multiple occasions. The most recent record was from 2019, 1.4km east of the site.
- 3.10 21 Red listed bird species were identified within 2km of the site; including turtle dove (*Streptopelia turtur*), starling (*Sturnus vulgaris*), fieldfare (*Turdus pilaris*) and mistle thrush (*Turdus viscivorus*).
- 3.11 26 Amber listed bird species were also identified within the desk study; including tawny owl (*Strix aluco*) wren (*Troglodytes troglodytes*), redwing (*Turdus iliacus*) and song thrush (*Turdus philomelos*).
- 3.12 One record of common lizard (*Zootoca vivipara*) was present within the desk study, 1.8km southeast of the site in 2020. Grass snake (*Natrix helvetica*) were recorded in 2019, 1.5km southeast of the site. Slow worm (*Anguis fragilis*) were recorded on several occasions, with the most recent record from 2021, 1.9km southeast of the site.
- 3.13 One record of the nationally scarce tangle web spider (*Theridion blackwalli*) was recorded in 2015, 0.6km north of the site.
- 3.14 Small heath (*Coenonympha pamphilus*) was identified on several occasions in 2019, with the closest record to the site just 0.6km to the south. White-letter hairstreak (*Satyrrium w-album*) was recorded in 2017, 1.9km southwest of the site.



3.15 A total of 83 moth species were identified; 56 of which are UK BAP, including cinnabar (*Tyria jacobaeae*) and latticed heath (*Chiasmia clathrate*)

*Walkover Survey*

3.16 The habitats on site were considered with respect to their potential to support protected species.

3.17 Within the redline boundary the site comprises a number of dominant ‘habitat types’, taken from those listed in the Handbook for Phase 1 Habitat Survey (JNCC, 2010). These habitat types are described below and are shown schematically on Figure 4. Target Notes (TN) are presented in Table 2. A list of plant species identified on site is included in Appendix C. The baseline conditions reported and assessed in this document represent those identified at the time of the survey on 26<sup>th</sup> August 2022. Although a reasonable assessment of habitats present can be made during a single walkover survey, seasonal variations are not observed.



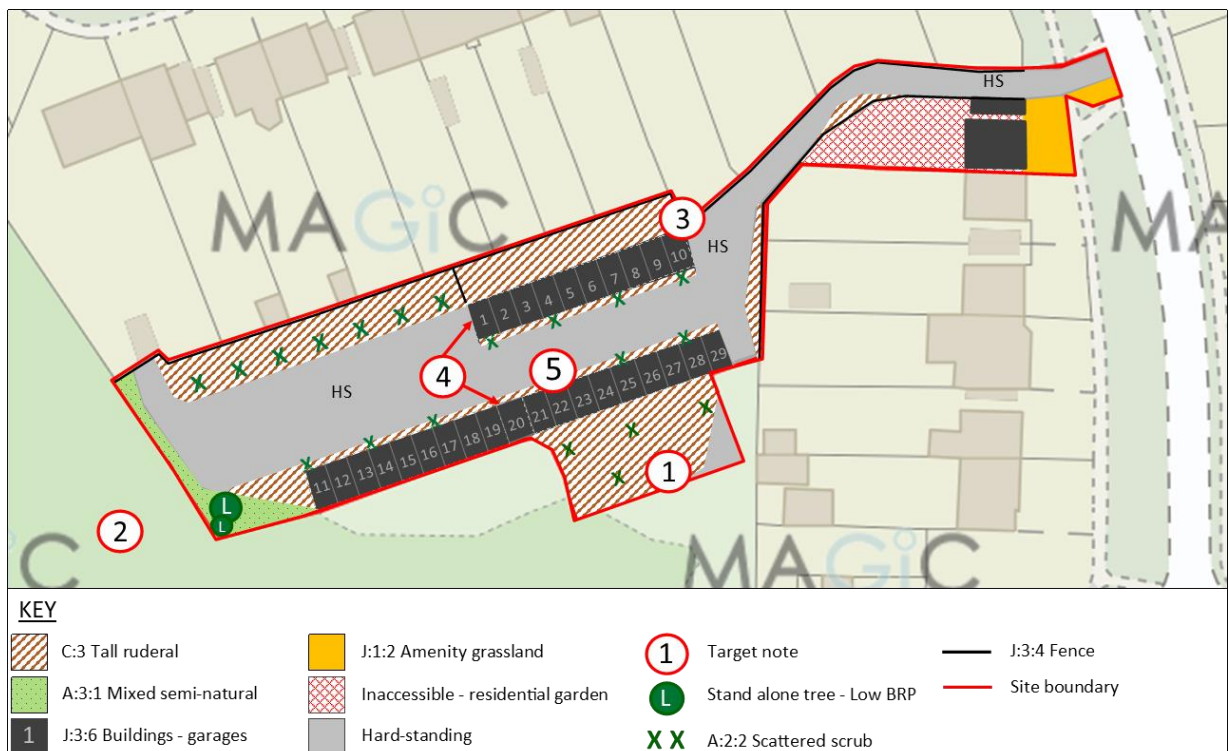

3.18 The site itself mainly consists of hardground, two rows of abandoned, single-storey garages, with some vegetation in the form of tall ruderal and scrub to the north and south.

3.19 The following photographs in Table 2 show the Target Notes referred to in Figure 4.

**Figure 4:** Phase 1 Habitat Map



**Table 2:** Target Notes

Target Note	Description	Photo
1	Badger droppings	
2	Waterlogged conditions, brash piles, and deer droppings within woodland (Just outside site boundary)	
3	Large hole in brick/concrete wall, into dark room – potential entry/exit point for roosting bats	
4	Abandoned garages	

Target Note	Description	Photo
5	Cotoneaster ( <i>Cotoneaster horizontalis</i> )	

## 4 Protected Species – Results and Evaluation

### *Badger*



- 4.1 The majority of habitats on site are considered unsuitable for badgers due to no or minimal cover for sett creation. The tall ruderal vegetation on site provides some foraging opportunities. Habitats directly adjacent the western and southern boundaries of the site boundary offer good potential for sett creation, as well as for foraging and commuting purposes.
- 4.2 No setts were discovered at the time of the survey within the tall ruderal and scrub habitats on site, or in the more suitable habitat adjacent the western and southern site boundaries. However, badger droppings were noted at the time of the survey within the tall ruderal towards the southern boundary of the site; this shows the site is currently in use by badgers, likely for foraging and commuting purposes.

### *Bats*

- 4.3 Two rows of garages are present on site, all of which are disused and dilapidated, lined with bramble and tall ruderal vegetation. The main structure of both rows of garages were constructed from concrete, with corrugated iron roofing and garage-style metal doors. Several of the garages were boarded up with chipboard, some had collapsed roofs, and majority contained an array of rubble and discarded material. Both rows of garages were assessed as having 'low' bat roosting potential (BRP) due to minimal features present; however, some aspects such as dark corners with lots of debris, cracks in the concrete structure, and gaps behind wooden boarding, could be suitable for small or singular roosts.
- 4.4 No trees are present on site; however, the canopies of two semi-mature oak trees overlapped the southwest corner of the site. These trees were assessed as having 'low' BRP due to some potential roosting features present, including cracked limbs and cavities.
- 4.5 See Table 3 for bat roosting feature photographs (numbering corresponds to those seen in Figure 4).
- 4.6 Habitat on-site was assessed as 'low' for foraging and commuting bats. Majority of habitats on site are hardstanding and buildings; however, areas of tall ruderal, particular on the northern boundary, as well as the woodland edge to the west and

south, have good suitability for a small number of foraging bats. The adjacent woodland also offers connectivity to the wider landscape.

**Table 3:** Photographs showing potential bat roost features

Potential bat roost features	Photo
<p>Group of two Oak (<i>Quercus robur</i>) trees</p> <ul style="list-style-type: none"> <li>- Cracked limbs</li> <li>- Cavities</li> </ul>	
<p>North row of garages</p> <ul style="list-style-type: none"> <li>- Large cavity into dark garage</li> <li>- Wooden boarding with lots of bramble coverage</li> <li>- Gaps at end of corrugated iron roofing</li> <li>- Cracks in concrete structure</li> </ul>	



#### *Mammals - Other*

- 4.7 The site provides some habitat for hedgehog due to scrub and tall ruderal that could provide shelter and foraging opportunities; however, this is limited due to the extent of hard standing. Access into some of the garages would be possible for hedgehogs, with the debris and discarded materials potentially also offering sheltering opportunities. However, no evidence of hedgehog was recorded during the walkover survey.
- 4.8 Evidence of muntjac deer was present within the woodland adjacent the western site boundary, through droppings. No other evidence of mammals using the site, or adjacent habitats, were present at the time of the survey.

#### *Birds*

- 4.9 Tall ruderal and scrub on site have some potential to provide nesting and foraging opportunities for birds. No trees are present on site; however, the oak tree which overhangs the site boundary has good nesting opportunities for birds.

- 4.10 Bird species observed during the walkover survey included; robin (*Erithacus rubecula*), pigeon (*Columba palumbus*), and magpie (*Pica pica*).

#### *Reptiles*

- 4.11 The majority of the site is hard standing; however, areas of tall ruderal offer suitable habitat for reptiles. Debris and discarded material within the garages also hold potential to act as sheltering habitats.
- 4.12 Large brash piles were present within the woodland to the west, approximately 10m outside the site boundary, which act as very suitable sheltering and hibernating habitats for reptiles.

#### *Amphibians*

- 4.13 No ponds were identified during the desk study search within 500m of the site boundary; however, waterlogged conditions within the woodland directly to the west of the site were assessed for habitat suitability. It was concluded that these waterlogged conditions have the potential to be suitable for GCN, particularly due to suitable vegetation and an abundance of hibernacula. However, these suitable waterlogged conditions are located approximately 20m from the western boundary of the site, and so are unlikely to be impacted by works. Brash piles on the woodland edge, rubble and material piles within the garages, and tall ruderal and scrub vegetation on site provide suitable hibernating habitat for great crested newts.

#### *Invertebrates*

- 4.14 The habitats on the site are unlikely to support a diverse assemblage of invertebrates. However, the scrub areas provide potential habitat for invertebrates such as small heath and latticed heath which were identified in the desk study.
- 4.15 No rare or protected invertebrate species were observed during the walkover.

#### *Flora*

- 4.16 No rare, principally important, local BAP or protected plant flora was identified during the walkover survey.
- 4.17 Cotoneaster (*Cotoneaster horizontalis*), a Schedule 9 invasive plant species, was found at the centre of the site.

## 5 Evaluation, Legislation and Recommendations

5.1 Table 4 below includes a summary of all identified and potential ecological constraints to the development, including those where there is insufficient information at the time of survey to be definitive. Relevant legislation has also been given here.

**Table 4:** Survey evaluation, relevant legislation and recommendations

Ecological Receptor	Summary of desk and walkover survey findings and relevant legislation	Likely impact and recommendations for further survey
Designated wildlife areas - statutory	<p>The desk study identified three LNR's and one SSSI within 7km of the site:</p> <ul style="list-style-type: none"> <li>• Marconi Ponds LNR (1.7km SE);</li> <li>• Chelmer Valley Riverside LNR (2.1km E);</li> <li>• Newney Green Pit SSSI (4.1km W); and</li> <li>• Galleywood Common LNR (4.9km S).</li> </ul>	<p>For new residential development in this area, financial contributions are required towards the emerging Essex Coast Recreational disturbance Avoidance and Mitigation Strategy (RAMS). Consultation between NE and the LPA may be required.</p>
Designated wildlife areas – non-statutory	<p>The desk study identified seven LWS within 2km of the site:</p> <ul style="list-style-type: none"> <li>• Writtle Bridge Meadows (0.3km S);</li> <li>• College Wood (0.9km N);</li> <li>• Daffy Wood (1.6km N);</li> <li>• Newland's Spring (1.7km N);</li> <li>• All Saints Church, Writtle (1.7km SW);</li> <li>• Marconi Ponds Nature Reserve (1.7km SE); and</li> <li>• Writtle Road Cemetery (2.0km SE).</li> </ul>	<p>The small-scale nature of the proposed development is unlikely to adversely impact the designated areas. No further assessment required.</p>
Habitats	<p>Habitats on the site comprise:</p> <ul style="list-style-type: none"> <li>• Hardstanding</li> <li>• Tall ruderal</li> <li>• Scrub</li> <li>• Boundary trees Woodland</li> </ul>	<p>Woodland on the western boundary of the site is a priority habitat. It is recommended this woodland section on site is retained and managed suitably.</p> <p>If this is not possible, any loss of this habitat will need to be mitigated for by replacement habitat on or off site.</p>
Badger	<p>Evidence of badger activity on site was recorded through droppings towards the southern boundary. No other evidence in terms of setts, pawprints or hair were recorded at the time of the survey.</p> <p>The site was considered suitable for sett creation, in particular, the scrub habitats.</p> <p>Badgers and their setts are protected under the Protection of Badgers Act 1992 and also protected by the Wild Mammals (Protection) Act 1996. Protection also extends to include disturbance.</p> <p>Under the Protection of Badgers Act 1992, it is an offence to intentionally or recklessly:</p> <ul style="list-style-type: none"> <li>• Kill, injure or take badgers;</li> <li>• Damage a badger sett or any part of it;</li> <li>• Destroy a badger sett;</li> <li>• Obstruct access to, or any entrance of a badger sett; and</li> <li>• Disturb a badger whilst it is occupying a badger sett.</li> </ul>	<p>If there is a delay in the commencement of works of up to 6 months prior to the commencement of construction, a badger check should be undertaken for the presence of setts. This is to assess any likely adverse impacts on active setts / or badgers using a sett for shelter or protection. Setts can extend up to 20m underground from their entrance.</p> <p>Surveys can be undertaken all year round with the optimum period being February to April or September.</p> <p>If the proposed works are likely to adversely impact a sett (if present), then a development licence would be necessary from Natural England prior to commencement.</p>



Ecological Receptor	Summary of desk and walkover survey findings and relevant legislation	Likely impact and recommendations for further survey
Bats	<p>The garages on site were assessed as having 'low' BRP due to several potential entry/exit points and some potential roosting features such as cracks, gaps, and lots of debris/discarded material.</p> <p>The two Oak trees overhanging the site boundary were also assessed as having 'low' BRP due to cracked limbs and cavities.</p> <p>The site was considered to have 'low' suitability for foraging and commuting bats; habitats can be used by small number of bats, with the adjacent woodland offering connectivity to the wider landscape.</p> <p>All species of bat are afforded full legal protection under Schedule 5 of the WCA. They are also listed under Schedule 2 of the Habitats Regulations. Some species of bat are also listed in Section 41 of NERC Act as an SPI.</p> <p>Combined legislation makes it an offence: to deliberately kill, injure, capture/take a wild bat; intentionally or recklessly disturb bats, including whilst occupying a place of shelter or protection; to damage or destroy a place used by a bat for breeding or resting (does not need to be deliberate, reckless or intentional); and to intentionally or recklessly obstruct access to any place used by a bat for shelter or protection.</p> <p>Bats are classed as 'European Protected Species' (EPS) and mitigation will typically be undertaken under the auspices of an EPS licence from Natural England.</p>	<p>It is recommended all trees overlapping the site boundary are maintained, with root protection zones (RPZs) incorporated into proposal plans.</p> <p>Bat emergence surveys are not considered necessary; however, as a precaution, the garages should be cleared under ecologist supervision using soft demolition. Demolition should take place outside the bat active season which is deemed to be from April to October.</p>
Mammals - other	<p>No evidence of hedgehogs was found during the walkover survey. The site provided some hibernation and foraging habitat for hedgehogs in tall ruderal and scrub habitats, as well as amongst debris/discarded materials within the garages.</p> <p>Hedgehogs are listed on Schedule 6 of the WCA which makes it illegal to kill or capture wild hedgehogs, with certain methods listed. The hedgehog is also a SPI under Section 41 of the NERC.</p> <p>All wild mammals are protected under the Wild Mammals (Protection) Act 1996. Offences relate to any act which results in the intent to inflict unnecessary suffering. Mercy killings and killing in a swift and humane way in the course of a lawful activity are not offences under the Act.</p>	<p>No further surveys recommended.</p> <p>It is recommended that if scrub is to be removed then scrub areas should be cut to 20cm using hand-held tools (brushcutter/trimmer) and checked for hedgehog before removal.</p> <p>See Section 6 for enhancements.</p>
Birds	<p>The following habitats have the potential to support breeding birds:</p> <ul style="list-style-type: none"> <li>• Overhanging trees;</li> <li>• Scrub; and</li> <li>• Tall ruderal</li> </ul> <p>No nests were present on site during the walkover survey.</p> <p>All wild birds while actively nesting are afforded legal protection under the WCA.</p> <p>Special protection is also afforded to birds listed on</p>	<p>It is recommended that any vegetation clearance and disturbance is undertaken outside of the nesting season. The nesting season is deemed to be from mid-March to mid-August, although these times can be temperature dependent.</p> <p>If this timing is not possible then a nesting bird check must be carried out by a suitably experienced person, no more than 48 hours between the check and the removal.</p>

Ecological Receptor	Summary of desk and walkover survey findings and relevant legislation	Likely impact and recommendations for further survey
	<p>Schedule 1 of the WCA which makes it an offence to disturb these species at nest or the dependent young.</p> <p>Combined legislation means that all birds, their nests and eggs are protected by law and it is an offence, with certain exceptions, to:</p> <ul style="list-style-type: none"> <li>a) intentionally kill, injure or take any wild bird;</li> <li>b) intentionally take, damage or destroy the nest of any wild bird while it is in use or being built;</li> <li>c) intentionally take or destroy the egg of any wild bird;</li> <li>d) have in one's possession or control any wild bird (dead or alive), part of a wild bird or egg of a wild bird;</li> <li>e) intentionally or recklessly disturb any wild bird listed on <b>Schedule 1</b> while it is nest building or is in, on or near a nest with eggs or young; or disturb the dependent young of such a bird; and</li> <li>f) have in one's possession or control any birds of a species listed on Schedule 4 of the Act unless registered in accordance with the Secretary of State's regulations.</li> </ul>	<p>If the 'all clear' is given, then removal/works can commence. The survey lasts for no longer than 48 hours. If works are not completed in this time frame, then a re-survey will need to be carried out.</p> <p>If birds are found to be nesting, then no works should be undertaken within at least 10m of the nest until chicks have fledged.</p>
Reptiles	<p>Some habitats on site are considered suitable for reptiles, such as the scrub and tall ruderal habitats, with the debris/discarded materials within the garages also offering some sheltering opportunities. Brash piles within the woodland to the west, approximately 10m outside the site boundary, provides further suitable habitat.</p> <p>Reptiles are afforded protection under Schedule 5 of the WCA from deliberate injury, killing and trade. They are also listed under Section 41 of NERC as an SPI.</p>	<p>No further survey recommended.</p> <p>It is recommended any clearance of vegetation and/or debris/discarded material piles, is done under ecologist supervision.</p>
Amphibians, particularly GCN	<p>No ponds were identified within 500m of the site boundary; however, within the woodland directly west of the site, waterlogged conditions were noted as potentially suitable for GCN.</p> <p>Tall ruderal and scrub on site provide suitable habitat for amphibians, including GCN. Debris and discarded material piles within the garages also provide sheltering opportunities.</p> <p>Both aquatic and terrestrial habitat is protected under wildlife legislation.</p> <p>GCN is afforded full legal protection under Schedule 5 of the WCA. It is also listed under Schedule 2 of the Habitats Regulations. This species is also listed under Section 41 of NERC as a species of Principal Importance.</p> <p>GCN are classes as a 'European Protected Species' and any necessary mitigation is typically undertaken under the auspices of a licence from Natural England.</p>	<p>It is recommended any clearance of vegetation and/or debris/discarded material piles, is undertaken between April and November, under the supervision of a GCN licenced ecologist (following Reasonable Avoidance Measures).</p> <p>If GCN are found to be present during the supervision works, then works must stop until an EPS licence from Natural England is acquired.</p> <p><b>Timings and consideration will also be needed in relation to nesting birds.</b></p> <p>It is also recommended that the woodland edge is managed sympathetically, with any vegetation clearance or removal of brash piles also done under ecologist supervision.</p>
Invertebrates	<p>The habitats on site are unlikely to support a diverse assemblage of invertebrates. However, areas of scrub can be used by a small number of invertebrates, such as butterflies.</p>	<p>No further surveys recommended. However, the woodland edge should be managed sympathetically.</p> <p>See Section 6 for enhancements.</p>

Ecological Receptor	Summary of desk and walkover survey findings and relevant legislation	Likely impact and recommendations for further survey
Flora	<p>The habitats on site are unlikely to support any rare or protected flora.</p> <p>Cotoneaster was found on site, which is a Schedule 9 invasive plant species.</p> <p>Schedule 9 includes certain plants that have become established in the wild in Great Britain but which the law seeks to prevent spreading further. The WCA creates various offences, including allowing a Schedule 9 plant to grow in the wild. Negligent or reckless behaviour such as inappropriate disposal, resulting in the plant becoming established in the wild also constitutes an offence.</p> <p>Depositing unauthorised 'controlled waste' (such as Japanese knotweed) is also likely to be a breach of Section 33 of the Environmental Protection Act, 1990.</p> <p>In the recent Court of Appeal decision in the case of <i>Network Rail Infrastructure Limited v Williams and Another</i> [2018], a landowner/occupier can be liable for failing to act reasonably to remove any Japanese knotweed after becoming aware of it and where it is foreseeable that it would damage neighbouring land.</p>	<p>No further surveys recommended.</p> <p>The woodland edge should be managed sympathetically.</p> <p>The cotoneaster should be removed from site and dealt with by a licensed specialist.</p>

## 6 Ecological Considerations and Enhancements

- 6.1 The proposed development is considered unlikely to be adversely detrimental to designated areas, protected species or habitats, provided the recommendations are followed in Table 5. However, a number of considerations and enhancements are recommended with respect to the overall biodiversity of the site in line with current Planning Policy.
- 6.2 A Biodiversity Net Gain (BNG) assessment may be requested by the LPA to provide a net gain of at least 10%. BNG calculations can be undertaken using Defra Metric 2.0 (2019, as amended) which involves comparing 'baseline' habitat measurements with proposed habitats, post-development.
- 6.3 Where possible, scrub and trees at the boundaries of the site should be retained with a ~2m buffer zone and enhanced to create corridors and shelter/foraging areas for wildlife including bats, birds, hedgehogs, and small mammals.
- 6.4 The addition of standard bird boxes on retained trees and proposed new buildings will attract a greater diversity of birds to nest. A number of 1SP Schwegler sparrow terraces should be installed onto new builds. These should be located out of direct sunlight and close to but not restricted by vegetation. A number of Schwegler Swift Bricks should also be installed on the periphery of the new builds.
- 6.5 The addition of bat boxes could also be installed on retained trees and proposed new buildings to provide roosting opportunities for common species.
- 6.6 Landscaping should incorporate native or wildlife attracting trees, shrubs, and wildflower areas as these would likely be of benefit to a variety of wildlife including, birds, bats and invertebrates, including pollinators. These wildflower areas can easily be incorporated into the 'Green Amenity Space' within current proposal plans.
- 6.7 'Hedgehog links' (i.e. 15cm diameter gaps at the base of fences) are recommended to enable small mammals to move through the development.

## 7 Conclusion

- 7.1 A Preliminary Ecological Appraisal was undertaken at Land at Medway Close, Chelmsford by James Blake Associates in support of a planning application for residential dwelling units and associated infrastructure.
- 7.2 The majority of the site comprises hardstanding and buildings, with tall ruderal, scrub, and boundary trees.
- 7.3 If there is a delay in works of up to 6 months, an updated badger survey will be required, to note any changes in the interim.
- 7.4 Current development proposals show demolition of the garages on site. Tall ruderal and scrub vegetation on site is also likely to be removed. A licenced GCN ecologist needs to be present during these works. Ideally for GCN this would be recommended to be carried out between late-March/April and October; however, due to the suitability of these habitats also for nesting birds, and given works will be done under supervision, clearance can begin at the soonest convenience.
- 7.5 If the precautionary measures for bats, birds, hedgehogs and GCN detailed in this report are followed, it is considered that the development is able to proceed with minimal impact on the local conservation status of any protected, principally important, or rare species within the area.
- 7.6 It is also considered that with a sensitive landscape scheme, and by including some, or all, of the additional enhancements, the site could be improved for local wildlife post development.

## 8 References

CIEEM (Chartered Institute of Ecology and Environmental Management) (2013) Guidelines for Preliminary Ecological Appraisal. Technical Guidance Series.

Collins, J. (ed.) (2016) Bat Surveys for Professional Ecologists: Good Practice Guidelines, third edition. The Bat Conservation Trust, London.

Gent, A.H. and Gibson, S.D., eds. (1998) *Herpetofauna Workers' Manual*. Peterborough, Joint Nature Conservation Committee.

Harris S, Cresswell P and Jefferies D (1989) Surveying Badgers, Mammal Society.

JNCC (2010) *Handbook for Phase 1 habitat survey: a technique for environmental audit (revised reprint)* JNCC: Peterborough.

### Web references

MAGIC: Designated area data downloaded from URL <http://www.magic.gov.uk/html>

Essex Field Club (EFC)

[https://www.swift-conservation.org/swift\\_bricks.htm](https://www.swift-conservation.org/swift_bricks.htm)

## 9 Bibliography

W.J. Cresswell, J.D.S. Birks, M. Dean, M. Pacheco, W.J. Trehella, D. Wells and S. Wray (2012) UK BAP Mammals Interim Guidance for Survey Methodologies, Impacts and Mitigation. Eds. The Mammal Society, Southampton.

English Nature (2004) *Guidelines for Developers*. English Nature, Peterborough.

Gregory, R. D. Wilkinson, N. I. Noble, D. G. Robinson, J. A. Brown, A. F. Hughes, J. Proctor, D. A. Gibbons, D. W. & Galbraith, C.A. (2007) The population status of birds in the United Kingdom and Isle of Man: an analysis of conservation concern 2002-2007 *British Birds* 95: 410-450.

HMSO (1981) Wildlife and Countryside Act. HMSO, London.

HMSO (1992) Protection of Badgers Act, HMSO London.

HMSO (2000) Countryside and Rights of Way (CRoW) Act. HMSO, London.

HMSO (2006) Natural Environment and Rural Communities Act HMSO, London.

HMSO (2017) Conservation of Habitats and Species Regulations 2010 (as amended) HMSO, London.

National Planning Policy Framework (2021).

## 10 Appendices

### Appendix A: Statutory designated wildlife sites within 7km

Site Name	Designation	Distance from Site	Description
Marconi Ponds	LNR	1.7km SE	1.1 ha of 'rural retreat' utilised for educational purposes. The site was developed in the 60's and 70's as filter beds. The now nature reserve is nearby a railway.
Chelmer Valley Riverside	LNR	2.1km E	17.6 ha of urban riverside, with a mosaic of unimproved grasslands, old hedges scrub, woodland, seasonal ponds, and the river Chelmer. Marshy habitat is present, and species seen include kingfisher and pyramidal orchid
Newney Green Pit	SSSI	4.1km W	0.08 ha of short semi-improved grassland with a badger sett and historic geological excavation.
Galleywood Common	LNR	4.9km S	A 44.56- hectare site consisting of areas of open space containing low growing shrubs, heathers, and grasses. The site also contains areas of bare ground, wetland, and scrub.

### Appendix B: Non-statutory designated wildlife sites within 2km

Site Name	Designation	Distance from Site	Description
College Wood	LWS	0.9km N	A 4.49-hectare site consisting of an ancient woodland with Hornbeam ( <i>Carpinus betulus</i> ), Hazel coppice ( <i>Corylus avellana</i> ) and Oak ( <i>Quercus robur</i> ). Wild service tree ( <i>Sorbus torminalis</i> ) and Midland hawthorn ( <i>Crataegus monogyna</i> ) are indicators of its ancient status.
Writtle Bridge Meadows	LWS	0.3km S	A 14.48-hectare site consisting of meadows that form a corridor of habitats on the outskirts of urban Chelmsford. The horse grazed meadow to the north of the River Can exhibits the most floristically diverse assemblage. The meadows to the east comprise of tall grass dominated sward. False Oatgrass ( <i>Arrhenatherum elatius</i> ) and Yorkshire fog are also abundant.
Daffy Wood	LWS	1.6km N	A 0.70-hectare site containing a woodland consisting of Pedunculate oak, Hornbeam and Sweet Chestnut ( <i>Castanea sativa</i> ). Daffodils found on the site may be the rare wild daffodil ( <i>Narcissus pseudonarcissus</i> subsp. <i>Pseudonarcissus</i> ) and is a locally significant feature.
Newland's Spring	LWS	1.7km N	Newland's Spring is a small fragment of woodland of 0.8ha, situated in the urban environs of Chelmsford.
All Saints Church, Writtle	LWS	1.7km SW	A 0.6ha churchyard site with contrasting areas of short mown and tall sward grassland left for wildlife. This grassland is likely to have evolved from a Lowland Meadows vegetation type. Churchyards often protect remnants of older grassland that have not been treated with chemical sprays and, as such, can remain floristically rich. This church provides an oasis of species diverse grassland.
Marconi Ponds Nature Reserve	LWS	1.7km SE	A 1.1-hectare site consisting of woodland, scrub, and ponds. A small area of grassland can be found at the northern end of the site which has a varied herb flora including common knapweed and St. Johns-worts. Species found on the site include mallards, smooth newts and common frogs.



Site Name	Designation	Distance from Site	Description
Writtle Road Cemetery	LWS	2.0km SE	A 5.14-hectare site with a variety of grasses including Bent grasses ( <i>Agrostis</i> spp.), Yorkshire fog ( <i>Holcus lanatus</i> ) and Red fescue ( <i>Festuca rubra</i> ).

### Appendix C: Flora list identified during the walkover survey

Common Name	Scientific Name
Cleavers	<i>Galium aparine</i>
Foxglove	<i>Digitalis purpurea</i>
Horse weed	<i>Erigeron canadensis</i>
Hairy fleabane	<i>Conyza bonariensis</i>
Wild dandelion	<i>Taraxacum</i>
Cape figwort	<i>Phygelius capensis</i>
Rock cotoneaster	<i>Cotoneaster horizontalis</i>
Ivy	<i>Hedera helix</i>
Purple toadflax	<i>Linaria purpurea.</i>
Welsh poppy	<i>Meconopsis cambrica</i>
Rose bay willow herb	<i>Chamaenerion angustifolium</i>
Hemp agrimony	<i>Eupatorium cannabinum</i>
Elder	<i>Sambucus</i>
Oak	<i>Quercus robur</i>
Common nettle	<i>Urtica dioica</i>
Curly dock	<i>Rumex crispus</i>
Broadleaf plantain	<i>Plantago major</i>
Viper's bugloss	<i>Echium vulgare</i>
Field thistle	<i>Cirsium arvense</i>



**create**  
CONSULTING  
ENGINEERS LTD

**LAND OFF MEDWAY CLOSE, CHELMSOFRD**  
**Flood Risk Assessment and Drainage Strategy – Revision A**

# LAND OFF MEDWAY CLOSE, CHELMSFORD

## Flood Risk Assessment and Drainage Strategy

**Clients:** Chelmsford City Council

**Engineer:** Create Consulting Engineers Limited  
BIC108 – The MedBIC,  
Alan Cherry Dr,  
Chelmsford  
CM1 1SQ

Tel: 01603 877010  
Email: [enquiries@createconsultingengineers.co.uk](mailto:enquiries@createconsultingengineers.co.uk)  
Web: [www.createconsultingengineers.co.uk](http://www.createconsultingengineers.co.uk)

**Report By:** George Baker, Bsc (Hons), Msc

**Reviewed By:** Tracey Tooke, BSc (Hons), MCIWEM

**Approved By:** Graham Sinclair, BSc (Hons), MSc, DIC, C.WEM, MCIWEM

**Reference:** GGB/VL/P22-2709/09 Rev A

**Date:** December 2022

**LAND OFF MEDWAY CLOSE, CHELMSOFRD**  
**Flood Risk Assessment and Drainage Strategy – Revision A**

---

# **LAND OFF MEDWAY CLOSE, CHELMSFORD**

## **Flood Risk Assessment and Drainage Strategy**

### **Revision A**

#### **Contents**

- 1.0 Introduction
- 2.0 Sources of Information
- 3.0 Site Setting
- 4.0 Scheme Description
- 5.0 Flood Risk Assessment
- 6.0 Foul and Surface Water Drainage and Flood Risk From the Development
- 7.0 Mitigation
- 8.0 Residual Flood Risks And Impacts to Surrounding Areas
- 9.0 Conclusions and Recommendations
- 10.0 References

#### **Figures**

- 1.1 Site Location Plan
- 3.1 British Geological Survey Bedrock Geology Mapping Extract (1:50,000 scale)
- 3.2 British Geological Survey Superficial Geology Mapping Extract (1:50,000 scale)
- 3.3 Identified Local Watercourse Map
- 5.1 Environment Agency Fluvial/ Tidal Flood Map
- 5.2 Environment Agency Surface Water Flood Risk Map
- 5.3 Environment Agency Surface Water Flood Depth Map 3.3% Event
- 5.4 Environment Agency Surface Water Flood Depth Map 1% Event
- 5.5 Environment Agency Surface Water Flood Depth Map 0.1% Event
- 5.6 Environment Agency Risk of Flooding from Reservoirs Map
- 6.1 Indicative Exceedance Flow Routes

#### **Appendices**

- A. Anglian Water Asset Location Search
- B. Essex and Suffolk Water Clean Water Asset Location Search
- C. Anglian Water Pre-Planning Enquiry Correspondence
- D. Greenfield/Brownfield Runoff Calculations
- E. Flow Calculations
- F. Essex SuDS Pro-forma

**Plans**

3556:02D	Site Location Plan
41368BWLS-01	Topographic Survey
2709/02/005	Foul and Surface Water Drainage Strategy
2709/02/002	Drainage Standard Details

**Registration of Amendments**

Revision	Amendment Details	Revision Prepared By	Revision Approved By
Rev A 11.08.2023	Amended to reflect drawing updates to the drainage strategy	GGB	GS

## 1.0 INTRODUCTION

### Brief

- 1.1 Create Consulting Engineers Ltd were instructed by Chelmsford City Council to undertake a Flood Risk Assessment (FRA) and Drainage Strategy to inform a residential development for Land off Medway Close, Chelmsford (Figure 1.1).

### Project Context

- 1.2 The Site comprises a parcel of Brownfield land, as shown in Figure 1.1. The Client intends to submit an outline planning application to develop the Site with six dwellings and associated access/infrastructure. Architect's Layouts showing the proposed scheme are included on Drawing 3556:02D.

### Planning Policy Context

- 1.3 The potential consequences of inappropriate development in a flood risk area for occupiers, either of the development or elsewhere, pose significant risks in terms of personal safety and damage to property.

### National Policy

- 1.4 The National Planning Policy Framework<sup>1</sup> (updated 2021) includes Government policy on development and flood risk stating that:

*167. When determining any planning applications, local planning authorities should ensure that flood risk is not increased elsewhere. Where appropriate, applications should be supported by a site-specific flood-risk assessment. Development should only be allowed in areas at risk of flooding where, in the light of this assessment (and the sequential and exception tests, as applicable) it can be demonstrated that:*

- a) Within the site, the most vulnerable development is located in areas of lowest flood risk, unless there are overriding reasons to prefer a different location;*
- b) The development is appropriately flood resistant and resilient such that, in the event of a flood, it could be quickly brought back into use without significant refurbishment;*
- c) It incorporates sustainable drainage systems, unless there is clear evidence that this would be inappropriate;*
- d) Any residual risk can be safely managed; and*
- e) Safe access and escape routes are included where appropriate, as part of an agreed emergency plan.*

---

<sup>1</sup> Ministry of Housing, Communities & Local Government., 2021. *National Planning Policy Framework (NPPF)*. [Online]. Available at: <https://www.gov.uk/government/publications/national-planning-policy-framework-2> [Accessed December, 2022].

- 
- 1.5 The Planning Practice Guidance to the NPPF<sup>2</sup> (updated August, 2021) requires that at the planning stage, the developer should prepare and submit an appropriate FRA to demonstrate how flood risk from all sources of flooding to the development itself and flood risk to others will be managed now and when taking climate change into account.
- 1.6 To comply with the NPPF a FRA must be submitted for planning applications for developments within flood zones 2 and 3 (medium or high risk of fluvial or tidal flooding) and for all developments located in Flood Zone 1 (low risk) which are 1 hectare or greater; which has been identified by the Environment Agency as having critical drainage problems; identified in a strategic flood risk assessment as being at increased flood risk in future; or that may be subject to other sources of flooding, where its development would introduce a more vulnerable use.
- 1.7 A FRA should be appropriate to the scale, nature and location of the development and should identify and assess the risk from all sources of flooding to and from the development and demonstrate how any flood risks will be managed over the lifetime of the development.
- 1.8 An assessment of surface water and drainage is also required as part of the FRA in order to demonstrate how flood risk to others will be managed following development and taking climate change into account.
- 1.9 The Planning Practice Guidance (substantially revised in March 2015 in relation to drainage) requires that sustainable drainage systems should be considered and included where practicable, in line with DEFRA Technical Standards<sup>3</sup>.
- 1.10 The Technical Standards are therefore a key reference document and should be used in the formulation of the surface water drainage strategy for a scheme of this nature. The standards include the following requirements:

***"Flood risk outside the development***

***S1*** *Where the drainage system discharges to a surface water body that can accommodate uncontrolled surface water discharges without any impact on flood risk from that surface water body (e.g. the sea or a large estuary) the peak flow control standards (S2 and S3 below) and volume control technical standards (S4 and S6 below) need not apply.*

---

<sup>2</sup> Ministry of Housing, Communities & Local Government., 2021. *Planning Practice Guidance (PPG) - Flood Risk and Coastal Change*. [Online]. Available at: <http://planningguidance.planningportal.gov.uk/> [Accessed December, 2022].

<sup>3</sup> Department for Environment and Rural Affairs (DEFRA)., 2015. *Sustainable drainage systems: non-statutory technical standards*. [Online]. Available at: <https://www.gov.uk/government/publications/sustainable-drainage-systems-non-statutory-technical-standards> [Accessed December, 2022].

**Peak flow control**

**S2** For greenfield developments, the peak runoff rate from the development to any highway drain, sewer or surface water body for the 1 in 1 year rainfall event and the 1 in 100 year rainfall event should never exceed the peak greenfield runoff rate for the same event.

**S3** For developments which were previously developed, the peak runoff rate from the development to any drain, sewer or surface water body for the 1 in 1 year rainfall event and the 1 in 100 year rainfall event must be as close as reasonably practicable to the greenfield runoff rate from the development for the same rainfall event, but should never exceed the rate of discharge from the development prior to redevelopment for that event.

**Volume control**

**S4** Where reasonably practicable, for greenfield development, the runoff volume from the development to any highway drain, sewer or surface water body in the 1 in 100 year 6 hour rainfall event should never exceed the greenfield runoff volume for the same event.

**S5** Where reasonably practicable, for developments which have been previously developed, the runoff volume from the development to any highway drain, sewer or surface water body in the 1 in 100 year, 6 hour rainfall event must be constrained to a value as close as is reasonably practicable to the greenfield runoff volume for the same event, but should never exceed the runoff volume from the development site prior to redevelopment for that event.

**S6** Where it is not reasonably practicable to constrain the volume of runoff to any drain, sewer or surface water body in accordance with **S4** or **S5** above, the runoff volume must be discharged at a rate that does not adversely affect flood risk.

**Flood risk within the development**

**S7** The drainage system must be designed so that, unless an area is designated to hold and/or convey water as part of the design, flooding does not occur on any part of the Site for a 1 in 30 year rainfall event.

**S8** The drainage system must be designed so that, unless an area is designated to hold and/or convey water as part of the design, flooding does not occur during a 1 in 100 year rainfall event in any part of: a building (including a basement); or in any utility plant susceptible to water (e.g. pumping station or electricity substation) within the development.



*S9 The design of the Site must ensure that, so far as is reasonably practicable, flows resulting from rainfall in excess of a 1 in 100 year rainfall event are managed in exceedance routes that minimise the risks to people and property.*

### **Structural Integrity**

*S10 Components must be designed to ensure structural integrity of the drainage system and any adjacent structures or infrastructure under anticipated loading conditions over the design life of the development taking into account the requirements for reasonable levels of maintenance.*

*S11 The materials, including products, components, fittings or naturally occurring materials, which are specified by the designer must be of a suitable nature and quality for their intended use.*

### **Designing for Maintenance Considerations**

*S12 Pumping should only be used to facilitate drainage for those parts of the Site where it is not reasonably practicable to drain water by gravity.*

### **Construction**

*S13 The mode of construction of any communication with an existing sewer or drainage system must be such that the making of the communication would not be prejudicial to the structural integrity and functionality of the sewerage or drainage system.*

*S14 Damage to the drainage system resulting from associated construction activities must be minimised and must be rectified before the drainage system is considered to be completed.”*

### County Council Policy

1.11 Essex County Council act as Lead Local Flood Authority (LLFA) for the area and are a statutory consultee for all major developments, which includes the following:

- 10 or more houses;
- a site of over 0.5 hectares where the number of houses are unknown;
- a building greater than 1000 square metres; and
- a site over 1 hectare.

- 1.12 The LLFA have produced a local SuDS Design Guide<sup>4</sup> which includes construction standards and provide assistance to developers in creating sustainable drainage systems on their sites as well as the LLFA's consenting policy and various protocols. Essex County Council also provide guidance within their Preliminary Flood Risk Assessment (PFRA)<sup>5</sup> and Flood Risk Management Strategy<sup>6</sup> on development and flood risk.

#### District Council Planning Policy

- 1.13 Chelmsford City Council are currently working on a new local plan<sup>7</sup> to replace the 2008 adopted Core Strategy and Development Control Policies document<sup>8</sup> and 2013 Focused Review<sup>9</sup> currently in place. These plans provide guidance relating to flood risk and drainage.
- 1.14 The relevant policy is as follows:

#### *Local Plan - Emerging*

- *Strategic Policy S3 – Addressing Climate Change and Flood Risk*
- *Strategic Policy S11 – Infrastructure Requirements*
- *Policy NE3 – Flooding / SuDS*
- *Strategic Growth Site 3b – East Chelmsford – Land North of Maldon Road (Employment)*
- *Strategic Growth Site 3c – East Chelmsford – Land South of Maldon Road (Employment)*
- *Strategic Growth Site 3d – East Chelmsford – Land North of Maldon Road (Residential)*

#### *Core Strategy and Development Control Policies (2008)*

- *CP10 – Protection From Flooding*
- *DC22 – Areas of Flood Risk*
- *DC25 – Water Efficiency and Sustainable Drainage Systems*

- 1.15 The relevant policies and text from these local planning documents have been considered as part of this Flood Risk Assessment and Drainage Strategy.

---

<sup>4</sup> Essex County Council The SuDS Design Guide [Online]. Available at: <https://www.essexdesignguide.co.uk/suds> Accessed December, 2022]

<sup>5</sup> Essex County Council Preliminary Flood Risk Assessment [Online]. Available at: [https://assets.publishing.service.gov.uk/government/uploads/system/uploads/attachment\\_data/file/698238/PFRA\\_Essex\\_County\\_Council\\_2017.pdf](https://assets.publishing.service.gov.uk/government/uploads/system/uploads/attachment_data/file/698238/PFRA_Essex_County_Council_2017.pdf) [Accessed December, 2022]

<sup>6</sup> Essex County Council Local Flood Risk Management Strategy [Online]. Available at: <https://flood.essex.gov.uk/our-strategies-and-responsibilities/our-local-flood-risk-management-strategy/> [Accessed December, 2022]

<sup>7</sup> Chelmsford Draft Local Plan Pre-Submission Document (Regulation 19 - Publication Draft) January 2018 (Accessed December, 2022) <https://www.chelmsford.gov.uk/planning-and-building-control/planning-policy-and-new-local-plan/new-local-plan/local-plan-examination/>

<sup>8</sup> Chelmsford Adopted Local Plan - Core Strategy and Development Control Policies, 2008 (Accessed December, 2022) <https://www.chelmsford.gov.uk/planning-and-building-control/planning-policy-and-new-local-plan/existing-local-plans/>

<sup>9</sup> Chelmsford Adopted Local Plan - Core Strategy and Development Control Policies Focused Review, 2013 (Accessed December, 2022) <https://www.chelmsford.gov.uk/planning-and-building-control/planning-policy-and-new-local-plan/existing-local-plans/>

- 1.16 As part of evidence gathering for the new Local Plan, Chelmsford City Council have produced a new Strategic Flood Risk Assessment (SFRA) Level 1 and 2<sup>10</sup> (JBA, 2018) provides a summary of the flood risks for the local area. Combined with the Chelmsford Surface Water Management Plan (2014)<sup>11</sup> and Chelmsford City Water Cycle Study Update (2018)<sup>12</sup> these documents provide information on local flood risks. These documents have been utilised as part of this assessment and are referenced where applicable throughout this report.

### Climate Change

- 1.17 Climate change has important implications for the assessment and management of flood risk. The NPPF requires that climate change is considered when making an assessment of flood risk posed to future development.
- 1.18 Climate change has the potential to affect all identified sources of flooding at the Site. The likely impacts of climate change include increased severity of rainfall events as well as wetter winters leading to higher groundwater levels and increased frequency and severity of surface water flooding.
- 1.19 The influence of climate change on rainfall intensity has been taken into account by the surface water drainage strategy outlined in Chapter 6 as an inclusion of 45% has been made for climate change for all rainfall events up to and including the 1 in 100 year event in accordance with NPPF requirements, and 'Flood Risk Assessments: Climate Change Allowances'<sup>13</sup>.

### **Objectives**

- 1.20 The following specific objectives were set by Create Consulting Engineers Ltd after a review of the available data:
- To assess the suitability of the scheme in relation to all sources of flooding;
  - To assess the flood risk posed by the scheme once it is complete and operational;
  - To suggest mitigation measures in order to reduce any residual risks to acceptable levels.

---

<sup>10</sup> Chelmsford City Council Strategic Flood Risk Assessment (SFRA) Level 1 and 2 (Accessed December, 2022)

<https://www.chelmsford.gov.uk/planning-and-building-control/planning-policy-and-new-local-plan/new-local-plan/evidence-base/>

<sup>11</sup> Chelmsford Surface Water Management Plan (Accessed December, 2022) <https://www.chelmsford.gov.uk/planning-and-building-control/planning-policy-and-new-local-plan/new-local-plan/evidence-base/>

<sup>12</sup> Chelmsford City Water Cycle Study Update (Accessed December, 2022) <https://www.chelmsford.gov.uk/planning-and-building-control/planning-policy-and-new-local-plan/new-local-plan/evidence-base/>

<sup>13</sup> Gov.uk ., 2022. *Flood Risk Assessments: Climate Change Allowances*. [Online]. Available at: <https://www.gov.uk/guidance/flood-risk-assessments-climate-change-allowances> [Accessed December, 2022].

---

### Constraints and Limitations

- 1.21 The copyright of this report is vested in Create Consulting Engineers Ltd and the Client, Chelmsford City Council. The Clients, or their appointed representatives, may copy the report for purposes in connection with the development described herein. It shall not be copied by any other party or used for any other purposes without the written consent of Create Consulting Engineers Ltd or the Clients.
- 1.22 Create Consulting Engineers Ltd accepts no responsibility whatsoever to other parties to whom this report, or any part thereof, is made known. Any such other parties rely upon the report at their own risk.
- 1.23 The Flood Risk Assessment addresses the flood risk posed to and from the proposed development, the extent of which is shown by the Site boundary, as indicated on the attached drawings.
- 1.24 This report has been undertaken with the assumption that the Site will be developed in accordance with the above proposals without significant change. The conclusions resulting from this study are not necessarily indicative of future conditions or operating practices at or adjacent to the Site.
- 1.25 Create Consulting Engineers Ltd has endeavoured to assess all information provided to them during this appraisal. The report summarises information from a number of external sources and cannot offer any guarantees or warranties for the completeness or accuracy or information relied upon. Information from third parties has not been verified by Create Consulting Engineers Ltd unless otherwise stated in this report.
- 1.26 The revised Construction (Design and Management) Regulations 2015<sup>14</sup> (CDM Regulations) came into force in April 2015 to update certain duties on all parties involved in a construction project, including those promoting the development. One of the designer's responsibilities is to ensure that the client organisation, in this instance Chelmsford City Council, is made aware of their duties under the CDM Regulations. Further information on the CDM Regulations is provided in the client guide and is available online. It has been assumed for the purposes of this assessment that the lead designer will be responsible for advising the Client.
- 1.27 The approach to this FRA follows the ethos of the CDM Regulation, inasmuch as during the assessment process the proposed development is considered and any foreseeable associated health and safety flood risks are identified. It is then considered how these flood risk can be eliminated, or mitigations identified to reduce or control them. The outcome of this assessment process is presented in this report. While preparing this FRA no other noteworthy or unique health and safety risk have been identified.

---

<sup>14</sup> Health and Safety Executive., 2015. *Construction (Design and Management) Regulations*. [Online]. Available at: <http://www.hse.gov.uk/pubns/indg411.pdf> [Accessed December, 2022].

## 2.0 SOURCES OF INFORMATION

2.1 The information contained in this report is based on a review of existing information and consultation with interested parties.

### Records Review

2.2 Key reports and websites reviewed as part of this study are listed in Table 2.1 below.

Document/Website	Author/Publisher	Date
Fluvial/Tidal Flood Maps, Groundwater Mapping – <a href="http://environment-agency.gov.uk">environment-agency.gov.uk</a>	Environment Agency (EA)	Accessed December 2022
Surface Water and Reservoir Flood Mapping – <a href="http://flood-warning-information.service.gov.uk">flood-warning-information.service.gov.uk</a>	GOV.UK	Accessed December 2022
BGS GeoIndex – Geology and borehole records - <a href="http://www.bgs.ac.uk/geoindex">www.bgs.ac.uk/geoindex</a>	British Geological Survey	Accessed December 2022
Essex County Council Preliminary Flood Risk Assessment (PFRA)	URS, Scott Wilson	2011
Essex County Council Local Flood Risk Management Strategy	Capita Symonds, Essex County Council	2013
Essex County Council SUDS Design Guide	Essex County Council	Accessed December 2022
Chelmsford Draft Local Plan Pre-Submission Document (Regulation 19 - Publication Draft)	Chelmsford City Council	January 2018
Chelmsford Adopted Local Plan - Core Strategy and Development Control Policies	Chelmsford City Council	2008
Chelmsford Adopted Local Plan - Core Strategy and Development Control Policies Focused Review	Chelmsford City Council	2013
Chelmsford City Council Strategic Flood Risk Assessment (SFRA) Level 1 and 2	JBA Consulting	2018
Chelmsford Surface Water Management Plan	Capita Symonds	2014
Chelmsford City Water Cycle Study Update	Chelmsford City Council	2018
Anglian Water Foul and Surface Water Asset Plans (Appendix A) and Pre-Planning Enquiry Report Correspondence (included as Appendix C)	Anglian Water	2022
Essex and Suffolk Clean water asset plan (Appendix B)	Essex and Suffolk Water	2022
Proposed Site Layout Plan (Drawing 3556:02B)	John Finch Partnership	October 2022
Topographic Survey (Drawing 41368BWS-01)	Survey Solutions	April 2022

**Table 2.1: Key Information Sources**

## Consultation

- 2.3 The agencies and individuals consulted as part of this exercise to obtain records or seek input to the proposals as part of this FRA are listed in Table 2.2 and key records are included in the appendices.

Consultee	Form of Consultation	Topics Discussed and Actions Agreed
Anglian Water Developer Services Team	Request for Asset Plans	Asset plans were requested in order to inform the foul and surface water drainage strategies.  The asset plans (Appendix A), dated 26 September, 2022 show foul water assets in the vicinity of the Site. A foul water 300mm VC gravity sewer runs through the western side of the Site. A Surface Water 600mm gravity sewer runs through the eastern side of the Site flowing north to south..
	Correspondence around Pre-Planning Assessment	At the time of writing this report, Anglian Water have been contacted regarding capacity of the surface and foul water network and we are awaiting a response (Appendix C)
Essex and Suffolk Water Developer Services Team	Request for Asset Plans	Asset Plans were requested in order to inform the foul and surface water drainage strategies.  The asset plans (Appendix B) show a 4 inch CL pipe running north south along the western footway of medway close, however it does not cross the Site.

**Table 2.2: List of Parties Consulted**

### Site Walkover

- 2.4 No site walkover was undertaken by Create Consulting Engineers Ltd.

### Site Investigation

- 2.5 No Site Investigation has been carried out for the purposes of this assessment.

### 3.0 SITE SETTING

#### Site Location

- 3.1 The Site lies to the west of Chelmsford, Essex, approximately 1.8 km northwest of Chelmsford Rail Station, at Ordnance Survey grid reference 568760E , 207629N. The Site lies within the administrative area of Chelmsford City Council (CCC) and consists of a parcel of brownfield land with its boundary shown on the attached drawings.

#### Description of Site and Surroundings

- 3.2 The Site comprises approximately 0.2382 ha of brownfield land, bounded to the north and east by the gardens of residential developments and to the south and west by dense forest and woodland.
- 3.3 The Site is irregularly shaped and is formed mainly of hard surfaced brownfield land with storage units/garages bounded by a mixture of hedgerow, semi-natural woodland, coniferous and broadleaved plantation woodland vegetation.
- 3.4 The Topographic Survey, included with this report on Drawing 41368BWLS-01, summarises elevations in the area of the Site. The Site generally falls to the southwest. Levels generally fall from 29.87 mAOD in the northeast area of the site to 29.40 mAOD in the southwest.

#### Geological/Hydrological Setting

##### Underlying Geology

- 3.5 British Geological Survey (BGS) mapping (1:50,000 scale)<sup>15</sup> (Figure 3.1) identifies bedrock geology at the Site to comprise London Clay Formation (clay, silt and sand). This is characterised by the BGS as mainly comprising bioturbated or poorly laminated, blue-grey or grey-brown, slightly calcareous, silty to very silty clay, clayey silt and sometimes silt, with some layers of sandy clay.
- 3.6 Superficial deposits across the majority of the Site (Figure 3.2) comprise the Head (clay, silt, sand and gravel) which forms a conformable relationship with Alluvium (clay, silt, sand and gravel) deposits to the west. Head is characterised by the BGS as poorly sorted and poorly stratified, angular rock debris and/or clayey hillwash and soil creep, mantling a hillslope and deposited by solifluction and gelifluction processes. Whereas Alluvium is defined by the BGS as unconsolidated detrital material deposited by a river, stream or other body of running water as a sorted or semi-sorted sediment in the bed of the stream or on its floodplain or delta, or as a cone or fan at the base of a mountain slope.

<sup>15</sup> British Geological Survey (BGS) Onshore GeoIndex., 2022. *DiGMapGB-50 Bedrock Geology and Superficial Deposits*. [Online]. Available at: [www.bgs.ac.uk/geoindex](http://www.bgs.ac.uk/geoindex) [Accessed December, 2022].

- 3.7 Proximate BGS borehole records<sup>16</sup> include TL60NE24 located approximately 360 m west of the Site, this recorded Head to 0.8 m below ground level (bgl) and Glacial Silts between 0.8 to 7.6 mbgl. This was underlain by Boulder Clay to 9.6 mbgl and Glacial Sand and Gravel to 13.1 mbgl and Boulder Clay from 13.4 to 21.0 mbgl

#### Surface Watercourses

- 3.8 The nearest watercourse to The Site is a tributary to the River Can (Chignall Brook) located approximately 60 m to the west, as shown on Figure 3.3.

#### Water Quality

- 3.9 The EA's river quality maps<sup>17</sup> indicate that the water quality in the Chignall Brook downstream of the Site, which is the receiving watercourse for runoff from the Site, has "moderate" ecological and "fail" Chemical quality.
- 3.10 According to the Defra Magic website<sup>18</sup>, the Site is within a Nitrate Vulnerable Zone (NVZ). NVZ guidance states that an NVZ 'is designated where land drains and contributes to the nitrate found in "polluted" waters'. It defines polluted waters as:
- Surface or ground waters that contain at least 50mg per litre (mg/l) nitrate;
  - Surface or ground waters that are likely to contain at least 50mg/l nitrate if no action is taken; and
  - Waters which are eutrophic, or are likely to become eutrophic if no action is taken;
- 3.11 The DEFRA guidance states that water is eutrophic if:
- "it contains levels of nitrogen compounds that cause excessive plant growth resulting in "an undesirable disturbance to the balance of organisms present in the water and to the quality of the water".
- 3.12 The EA website indicates that the NVZ designation for the Site relates to polluted surface water.

---

<sup>16</sup> British Geological Survey (BGS) Onshore GeoIndex., 2022. *Borehole records*. [Online]. Available at: [www.bgs.ac.uk/geoindex](http://www.bgs.ac.uk/geoindex) [Accessed December, 2022].

<sup>17</sup> Environment Agency (EA)., 2022. *Catchment Data Search*, [Online]. Available at: <https://environment.data.gov.uk/catchment-planning/> [Accessed December, 2022].

<sup>18</sup> Department for Environment and Rural Affairs (DEFRA) Magic Website., 2017. [Online]. *Nitrate Vulnerable Zones (NVZ) – Combined (Final Designations)*. Available at: <https://magic.defra.gov.uk/MagicMap.aspx> [Accessed December, 2022].



### Groundwater

- 3.13 The site is underlain by a Secondary Undifferentiated Superficial aquifer<sup>19</sup> defined by the Environment Agency as:

*'it has not been possible to attribute either category A or B to a rock type'. Category A is defined as 'permeable strata capable of supporting water supplies at a local rather than strategic scale and in some cases forming an important source of base flow to rivers' and Category B is defined as 'predominantly lower permeability strata which may in part have the ability to store and yield limited amounts of groundwater by virtue of localised features such as fissures, thin permeable horizons and weathering'.*

- 3.14 The site is also underlain by an unproductive bedrock aquifer<sup>10</sup>.
- 3.15 The Site does not lie within any Groundwater Source Protection Zones<sup>20</sup>, as identified by the Environment Agency.
- 3.16 Groundwater was found within Borehole record<sup>7</sup> TL60NE24, which recorded strikes at 7.5 and 9.5 mbgl respectively.

### Artificial Water Bodies

- 3.17 The nearest water body to the Site is a reservoir at Chignall Hall Farm located approximately 2.8km northwest of the Site.

### Public Sewers and Water Supply Mains

- 3.18 Anglian Water (AW) are the statutory sewerage undertaker for the area and responsible for the operation and maintenance of public sewers serving Chelmsford.
- 3.19 Foul sewers present in the immediate vicinity of the Site are shown within sewerage asset mapping provided by AW (Appendix A) and comprise:
- A 300 mm VC diameter gravity foul sewer network serving development leading off Medway Close and crosses the western side of the Site. This flows to the southeast across the Site to a connection at AW manhole 7501.
  - A 600mm diameter VC gravity sewer flowing from Medway Close then crosses the site and runs southwest to a connection at AW manhole 7552.

---

<sup>19</sup> Department for Environment and Rural Affairs (DEFRA) Magic Website., 2010. [Online]. *Environment Agency Aquifer Designation Data*. Available at: <https://magic.defra.gov.uk/MagicMap.aspx> [Accessed December, 2022].

<sup>20</sup> Department for Environment and Rural Affairs (DEFRA) Magic Website., 2019. [Online]. *Environment Agency Source Protection Zones (Merged)*. Available at: <https://magic.defra.gov.uk/MagicMap.aspx> [Accessed December, 2022].

- 3.20 Essex and Suffolk Water are also the potable water supplier for the area, asset plans contained within Appendix B, indicate that water supply assets are generally located within the service corridors of the roads in close proximity to the Site, including Medway Close to the east of the Site. These can be found beneath the east and west footway of Medway Close, recorded as having a 4 inch diameter.

Existing Site Drainage

- 3.21 The Topographic Survey (Drawing 41368BWLS-01) shows that the site has gully drains that drain the surface water from the Site, which we assume drains to the AW network.

## **4.0 SCHEME DESCRIPTION**

### **The Scheme**

- 4.1 The Client intends to apply for planning permission to develop the Site with six dwellings and associated access and infrastructure.
- 4.2 The proposed scheme is shown on Drawing 3556:02 appended with this report.

### **Proposed Land Use Vulnerability Classification**

- 4.3 The development is proposed to include residential dwellings which is defined as a 'more vulnerable' use according to the NPPF.
- 4.4 Given the proposed land use classification and the location of the Site within the surface water flood zone the Sequential and Exception tests may be required. The Sequential tests does not form part of this report and will be submitted under separate cover, should this be required.

## 5.0 FLOOD RISK ASSESSMENT

### Scope of Work

- 5.1 The scope of this FRA was refined to meet the brief outlined in Chapter 1 of this report and considers the following:
- Flood risk to the development from all sources;
  - Potential for the design, construction and operation of the Site to increase the risk of flooding to neighbouring properties;
  - Any necessary mitigation measures to mitigate identified potential flood risks;
  - Climate change;
  - Residual flood risks.
- 5.2 The approach is consistent with the NPPF<sup>1</sup> and its associated Technical Guidance<sup>2</sup> along with the requirements of local planning policy.

### Flood Risk to the Proposed Development

#### Flood Risk from Fluvial/Tidal Sources

- 5.3 EA flood mapping<sup>21</sup>, as shown on Figure 5.1, indicates that the Site is located within Flood Zone 1. Flood Zone 1 is defined as areas with a 'low' probability of inundation defined as having a less than 1 in 1,000 annual probability of river (fluvial) or sea (tidal) flooding (<0.1%).
- 5.4 Review of available flood investigation records provided by Essex County Council<sup>22</sup> has identified no record of flooding from this source affecting the Site or the surrounding area.
- 5.5 Given the above the Site is considered to be at a low risk of fluvial/tidal flooding, therefore this source is not considered further within this report.

#### Flood Risk from Surface Water

- 5.6 The EA Surface Water Flood Mapping<sup>23</sup>, as shown on Figure 5.2, shows that there are number areas of flow path within the Site; running northeast to southwest with the central line of that run being high risk (3.3%) and as you move north and south from the centre of the site it gradually lessens to medium risk (1%) then to low risk (0.1%).

---

<sup>21</sup> Environment Agency., 2022. *Flood Map for Planning (Rivers and Sea) - Flood Zone 2 and Flood Zone 3*. [Online]. Available at: <https://data.gov.uk/dataset/cf494c44-05cd-4060-a029-35937970c9c6/flood-map-for-planning-rivers-and-sea-flood-zone-2> [Accessed December, 2022]

<sup>22</sup> Essex County Council., Various. *Flood Investigation Reports*. [Online]. Available at: <https://flood.essex.gov.uk/know-your-flood-risk/check-if-you-re-at-risk-of-flooding/> [Accessed December, 2022].

<sup>23</sup> Environment Agency., 2022. *Risk of Flooding from Surface Water Extent: 3.3 percent annual chance, 1 percent annual chance and 0.1 percent annual chance*. [Online]. Available at: <https://data.gov.uk/dataset/95ea1c96-f3dd-4f92-b41f-ef21603a2802/risk-of-flooding-from-surface-water-extent-3-3-percent-annual-chance> [Accessed December, 2022].

- 5.7 Flood depths across the majority of the site remain below 600 mm for both the High (Figure 5.3) and Medium (Figure 5.4) risk events. However, in the Low risk scenario, a small portion of the eastern side of the Site reaches depths between 900 mm and 1200 mm (Figure 5.5).
- 5.8 Surface Water flood risk modelling and mapping has been undertaken as part of the SFRA, for the 1 in 100 year event with an inclusion for 40% climate change. The results of which show the climate change extent closely matches, with slight increases, the current 1 in 100 year flood risk extent provided by the above referenced mapping.
- 5.9 Given the nature of the proposed development and the fact dwellings will be placed away from primary flow routes, it is considered that the risk from surface water flooding is generally low, however appropriate mitigation measures are included in Table 7.1 of this report.

#### Flood Risk from Groundwater

- 5.10 The Chelmsford City Council (CCC) SFRA includes mapping showing groundwater flooding susceptibility, based on the AStGWf dataset provided by the BGS<sup>24</sup>. This shows that up to 75% of the site is susceptible to groundwater flooding. It should be noted however, that this dataset identifies areas where the local geological and hydrogeological conditions may allow groundwater to emerge and does not represent flood risk.
- 5.11 Based on the results of groundwater strikes in BGS borehole TL60NE24 at 7.5 and 9.5mbgl, the risk of groundwater flooding in this location is considered to be low.
- 5.12 The effect of climate change on groundwater flooding is also currently uncertain. Milder wetter winters may increase the scale and frequency of flooding however, warmer drier summers may counteract this effect by drawing down groundwater levels to a greater extent during the summer months. This is considered as part of the residual risk identified above and appropriate mitigation measures are included in Table 7.1 of this report.

#### Flood Risk from Artificial Water bodies

- 5.13 The nearest artificial waterbody to the site is a reservoir located approximately 2.8km to the northwest. This is a reservoir currently used by Chignall Hall Farm.
- 5.14 The Site is not in an area mapped by the EA to be at risk from flooding during a reservoir breach event<sup>25</sup>, as shown by figure 5.6

---

<sup>24</sup> British Geological Survey (BGS), 2022. *Groundwater Flooding Susceptibility AStGWf Dataset*. [Online]. Available at: <https://data.gov.uk/dataset/f0329412-b46a-49b0-9f30-abef8c4b807e/groundwater-flooding-susceptibility> [Accessed December, 2022].

<sup>25</sup> Environment Agency., 2022. *Risk of Flooding from Reservoirs - Maximum Flood Extent (Web Mapping Service)*. [Online]. Available at: <https://data.gov.uk/dataset/44b9df6e-c1d4-40e9-98eb-bb3698ecb076/risk-of-flooding-from-reservoirs-maximum-flood-extent-web-mapping-service> [Accessed December, 2022].

---

### Flood Risk from Public Sewers

- 5.15 The SFRA shows no record of sewer flooding affecting the site or the immediate area. The risk of sewer flooding is therefore considered to be low.
- 5.16 Sewer flooding from blockage of private site and building drainage as well as the AW network is, however, a residual risk managed by the design of the Site drainage and regular inspection and maintenance of the public and private sewer network. The flood risk associated with this source may also increase over time due to the effects of climate change. Appropriate mitigation measures are therefore included in Table 7.1 of this report.

### Flood Risk from Water Mains

- 5.17 Flood risk from this source is considered to be a risk during construction as there are existing mains shown within the supplied AW asset plans (Appendix A) crossing the site or within the immediate area. The main threat therefore will be from damage to existing and newly constructed internal pipe work during the construction phase or as a result of any future individual property building works. Appropriate mitigation measures are discussed in Table 7.1 below.

### Flood History

- 5.18 Review of available flood investigation records provided by Essex County Council<sup>22</sup> and the Chelmsford City Council SFRA<sup>26</sup> has identified no record of flooding from this source affecting the Site.

### Flood Risk Summary

- 5.19 In summary, the risk of flooding from all sources is generally considered to be low, however, the risk from surface water remains as well as residual risks from groundwater, public sewers and water mains. A number of mitigation measures are recommended in Table 7.1 to address and manage surface water flood risk and the residual risks from these forms of flooding.

---

<sup>26</sup> Chelmsford City Council., 2018 Preliminary Flood Risk Assessment 1 and 2 [Online]. Available at <https://www.essexdesignguide.co.uk/media/1522/chelmsford-sfra-1-1-and-1-2-final-report-v10-oct-2017.pdf> [Accessed December, 2022].

## 6.0 FOUL AND SURFACE WATER DRAINAGE AND FLOOD RISK FROM THE DEVELOPMENT

### Existing Foul Water Drainage

- 6.1 Although the site is currently brownfield in nature there doesn't appear to be foul drainage on site given the current uses.

### Proposed Foul Water Drainage Strategy

- 6.2 Foul water from the Site will be designed to drain via gravity to the west of the site boundary, to a new connection on the Anglian Water foul sewer that runs through the site, this will then drain south to Anglian Water manhole 7501 (which lies within the ownership of the applicant). The foul water drainage proposals are included on Drawing 2709/02/005 appended to this report.
- 6.3 At the time of writing this report, Anglian Water have been contacted regarding the foul water drainage capacity and we are awaiting a response. Correspondence of which can be found in Appendix C.

### Existing Surface Water Drainage

- 6.4 Calculations included in Appendix D estimate the current Greenfield runoff rates from the Site as shown in Table 6.1.

Rainfall Event	Greenfield Runoff Rate (Equivalent to Proposed Impermeable Areas) (l/s)	Brownfield Runoff Rate from Existing Impermeable Area (l/s)
Q 1 year	0.4	23.82
Q 30 year	0.9	58.39
Q 100 year	1.3	75.29

**Table 6.1: Greenfield Runoff Rates from the Site for Various Rainfall Events.**

- 6.5 As noted in Chapter 3 the Site is currently free draining to surrounding and internal gully drains, which are assumed to drain to the AW surface water sewer network.

### Proposed Surface Water Drainage Strategy

- 6.6 The following provides a summary of the proposed method of management and disposal of surface water runoff from the Site:
- As part of the design process sustainable drainage methods have been included where practicable, to provide the required attenuation in accordance with the SUDS hierarchy (see Table 6.2).

- Surface water flows will be attenuated using SUDS such that flows from the Site are restricted (with an allowance for an increase in rainfall intensity of 45% due to climate change) prior to a discharge into new connection to the Anglian Water surface water network upstream of Manhole 7552.
- A single outfall is proposed using a gravity connection outfall flowing to the eastern boundary of the Site;
- There is little potential for Infiltration forms of SUDS (i.e. soakaways) to be viable due to the superficial deposits shown in Borehole TL60NE24 approximately 200m west of the Site. This borehole shows that the first 5.0 m below the Site is likely made of clay rich deposits which means that the Site is unlikely to infiltrate. On the basis that infiltration systems are not viable the following forms of SUDS are proposed, as shown on Drawing 2709/02/005:
  - 0.7m depth tanked permeable paving will provide 121.2587m<sup>3</sup> of storage for the 1 in 100 year plus 45% climate change event. This is shown in the Flow calculations included in Appendix E
  - A flow control restricting runoff to the lowest operable rate of 1.0 l/s be included prior to the discharge into the Anglian water surface water sewer network. This will restrict flows to this level for all events up to and including the 1 in 100 year plus 45% climate change event.
  - Roof areas will also drain via the permeable paving to receive appropriate levels of treatment with a further summary on SuDS mitigation indices below.
- The 1.0 l/s restricting flow rate is the lowest operable rate for the proposed impermeable areas of the developed area (0.1568ha) of the Site (i.e. the Site area excluding public open space and tree belts etc.), as shown by the calculations included in Appendix D.
- Baffles are proposed on the access road for the permeable paving as the Site drops 1.5m over the section between the entrance point and dwellings, the locations of these baffles will be considered further at the detailed design stage.
- Appropriate pollution control measures have been incorporated in line with guidance provided by the SUDS Manual and is detailed further below.
- It is recommended that the downstream flow route from the point of outfall should be fully surveyed, desilted and jetted as required prior to any new connection being made.
- An allowance for future urban creep has also been included, within the above calculations, of 10% of the measured impermeable area of the site.
- Relevant SuDS pro-forma has been completed and included as appendix F.

6.7 A summary of the potential SUDS options which led to the above drainage strategy is included in Table 6.2. This drainage strategy however is considered to be in compliance with both local and national policy as summarised in Section 1 of this report.



SUDS Option	Suitability/Included in the Scheme?	Comments
Soakaways and porous paving	x	Geology likely not suitable for infiltration as shown in Borehole TL60NE24 however testing may be undertaken at the detailed design stage.
Porous paving (storage)	✓	0.7m depth tanked permeable paving will be used for private drives and roadways for storage.
Rainwater Harvesting	*	Not included in the client and architect design proposal at present.
Swales	x	Not included in the client and architect design proposal at present and not viable due to space constraints on site
Attenuation Ponds (above ground storage)	x	Not included in the client and architect design proposal at present and not viable due to space constraints on site
Below ground storage in cellular systems	x	Not included in the client and architect design proposal at present.
Flow control devices	✓	Hydrobrake Vortex Control restricting flows to 1.0l/s is included within the scheme
Green Roofs/Brown Roofs/Blue Roofs	*	Not included in the client and architect design proposal at present.

**Table 6.2: SUDS Options**

Key:

✓ *Suitable for use and included in the scheme*

\* *Possibly suitable for use – not included in the client and architect design proposal at present – should be considered further as part of the detailed design*

x *Unlikely to be suitable for use*

### Surface Water Drainage Management and Maintenance

- 6.8 Given the small scale nature of the site and the fact no adoptable roadways are proposed all drainage will likely remain private and under the control of a private management company.
- 6.9 Further detail regarding the exact management and maintenance procedures required will be provided as part of any reserved matters submission once a management company has been instructed and a scope agreed. This will however, follow the principles set out in Table 6.3 below:
- 6.10 A summary of the required measures for the drainage assets on site is as follows:

Maintenance Schedule	Required Actions	Typical Frequency
<b>Permeable paving</b>		
Regular Maintenance	Brushing and vacuuming (standard cosmetic sweep over whole surface)	Once a year, after autumn leaf fall, or reduced frequency as required, based on site-specific observations of clogging or manufacturer's recommendations—pay particular attention to areas where water runs onto pervious surface from adjacent impermeable areas as this area is most likely to collect the most sediment
Occasional Maintenance	Stabilise and mow contributing and adjacent communal areas	As required
	Removal of weeds or management using glyphosate applied directly into the weeds by an applicator rather than spraying	As required/once per year on less frequently used pavements
Remedial Actions	Remediate any landscaping which, through vegetation maintenance or soil slip, has been raised to within 50mm of the level of the paving	As required
	Remedial work to any depressions, rutting and cracked or broken blocks considered detrimental to the structural performance or a hazard to users, and replace lost jointing material	
	Rehabilitation of surface and upper substructure by remedial sweeping	Every 10 to 15 years or as required (if infiltration performance is reduced due to significant clogging)
Monitoring	Initial inspection	Monthly for three months after installation
	Inspect for evidence of poor operation and/or weed growth—if required, take remedial action	Three-monthly, 48h after large storms in first six months
	Inspect silt accumulation rates and establish appropriate brushing frequencies	Annually
	Monitor inspection chambers	

Maintenance Schedule	Required Actions	Typical Frequency
<b>Other General:</b>		
Regular Maintenance	Inspect rainwater gutter channels, inlets and outlets for blockages and clear as required.	Monthly for first year then annually thereafter
	Inspect gully drains, channel drains and inspection chambers (including silt traps) for siltation/blockage.	Monthly for first year then annually thereafter
	Inspect for sediment and debris in manhole bases and any blockage of soakaway chamber and geocellular storage.	Bimonthly for first six months then every six months thereafter
	Remove litter and debris from swale. Carry out periodic mowing of grassed surface and inspect for silt accumulation to determine appropriate removal frequency.	Monthly or as required (and through growing season for swales)
	Remove any sediment and debris from base of chambers and cellular storage.	As required, based on inspections
Occasional Maintenance Remedial Actions	Remove sediment from any affected articles including silt traps and soakaways (most likely via jetting).	As required
	Clear any pipe blockages with appropriate equipment	As required
	Repair any damage arising from various inspections (by approved engineer where required)	As required
	Replacement of permeable surfacing, manhole components, silt traps and cellular soakaways should failure occur.	As required

**Table 6.3: SuDS Management and Maintenance Requirements**Exceedance Flows

6.11 Exceedance flow routes are shown on Figure 6.1, these may be adapted to suit any proposed changes to the Site layout as the design progresses in line with the following principles:

- Surcharged flows from highways, private drives and roof areas will be retained within kerb lines and channelled towards the east;
- External ground levels will be profiled such that no ponding occurs against buildings, with flows directed as above;
- All flows in excess of the drainage network design standard will be channelled to the permeable paving which has been sized to accommodate the 1 in 100 year plus climate change event whilst also allowing a suitable freeboard for inflows above this.

- For exceedance events beyond 1 in 100 plus climate change, the water will run off towards the south of the site as per the existing scenario.

### Pollution Control

- 6.12 Pollution control requirements are determined by the using the Simple Index Approach as detailed in the CIRIA SuDS Manual.
- 6.13 Suitable pollution hazard indices are allocated for the proposed land uses. The indices range from 0 (no pollution hazard for this contaminant type) to 1 (high pollution hazard for this contaminant type).
- 6.14 From the designated hazard indices a total SuDS mitigation index is calculated for each of suspended solids, metals and hydrocarbons using:

$$\text{Total SuDS mitigation index} = \text{mitigation index}_1 + 0.5(\text{mitigation index}_2)$$

Where:

*Mitigation index<sub>n</sub>* = mitigation index for component *n*

- 6.15 To deliver adequate treatment the selected SuDS components should have a total pollution mitigation index (for each contaminant type) that equals or exceeds the pollution hazard index (for each contaminant type).

$$\text{Total SuDS mitigation index} \geq \text{pollution hazard index}$$

- 6.16 In this case the SuDS pollution hazard indices are detailed in Table 6.4.

Land Use	Total Suspended Solids	Metals	Hydrocarbons
Residential Roofs	0.2	0.2	0.05
Individual property driveways, residential car parks, low traffic roads, and non-residential car parking with infrequent change	0.5	0.4	0.4

**Table 6.4: SuDS pollution hazard indexes for the Site**

- 6.17 Roofs and external areas will drain through tanked permeable paving. This provides mitigation indices that equal or exceed those required for the Site in all cases (Table 6.5) and therefore is considered an appropriate method to deliver adequate pollution mitigation treatment with the permeable paving ultimately providing treatment extra over that required for those relevant areas.

SuDS Component	Total Suspended Solids	Metals	Hydrocarbons
Permeable Paving	0.7	0.6	0.7

**Table 6.5: Indicative SuDS mitigation indices**

- 6.18 It should be noted that SuDS components only deliver these indices if they follow design guidance with respect to hydraulics and treatment set out in the relevant technical component chapters of the CIRIA SuDS Manual.

### **Flood Risk from the Development**

- 6.19 As the development of the Site will introduce hard surfacing, the runoff characteristics will be significantly altered. Therefore an assessment of the proposed surface and foul water drainage scheme is required to ensure the scheme does not increase flood risk to the surrounding area.
- 6.20 The following sections provide a drainage assessment of the scheme and appropriate mitigation measures are presented in Table 7.1

#### Effects on the Public Foul Sewer Network

- 6.21 As the Site will now produce foul water flows AW have been consulted to confirm there will be no detriment to the surrounding foul water network as a result of the scheme.
- 6.22 At the time of writing we are still waiting for a response, correspondence can be found in Appendix C.

#### Effects on Nearby Watercourses

- 6.23 As the majority of the Site is free draining, it is assumed that under current conditions, any surface water will currently pond or runoff overland during extreme rainfall events. Following development, the surface water drainage strategy set out above ensures that sufficient sustainable drainage systems will be included to make sure that there are no significant changes in surface water runoff from the Site compared to the existing situation (for all rainfall events up to the 1 in 100 year rainfall event including an allowance for climate change). Calculations in Appendix F confirm this.
- 6.24 For all events beyond the 1 in 100 year plus climate change rainfall event, the situation will be no worse than existing, as long as a consideration of exceedance flows is made as part of the detailed drainage design to ensure that any excess surface water runoff would continue to overflow away from the existing and proposed residential properties.

## 7.0 MITIGATION MEASURES

7.1 Flood Risk Mitigation measures are proposed in Table 7.1 in order to both mitigate flood risk posed to the development and to ensure the development poses no risk to the surrounding area.

Type of Flooding (Source)	Issue	Mitigation Measures	Justification	Residual Risk *
Flooding from surface water runoff – overland flow/ponding	Risk of flooding from rainfall events in exceedance of the site drainage design and by run-off from surrounding areas, may result in on-site property flooding.	<ul style="list-style-type: none"> <li>• Finished Floor Levels will be raised to 29.75mAOD for Plots 1-4 and to 29.85mAOD Plots 5-6, which equates to a increase of between 300-350mm (Plots 1-4) and 400-500mm (plots 5-6) over existing ground levels.</li> <li>• Plot 6 will have a sacrificial ground floor with only parking and access areas included at this level, given this plots position within the surface water flood zone.</li> <li>• Appropriate flood resilience/resistance measures will be included on the ground floor in agreement with the relevant authorities. These could include, but are not limited to: <ul style="list-style-type: none"> <li>• The provision of the necessary infrastructure to allow flood defence residential doors to be installed at the pedestrian entrances to the properties;</li> <li>• Electrical wiring feeding low level points and switches should drop from the ceiling rather than be fed from floor level. Switches and points should be raised as high as reasonably practicable and within Building Regulations standards.</li> <li>• Use of dry-proofing and wet-proofing building materials;</li> <li>• Water resistant coatings for external walls;</li> <li>• Raise plant as high as practically possible;</li> <li>• Non-return valves will be considered for foul/surface water sewers to prevent backflow;</li> <li>• Use of concrete or hard surfaced floors rather than timber or soft coverings. Or use of waterproof floor coverings with appropriate sealing such as Aquastep;</li> <li>• Location of boilers as high as possible;</li> <li>• PVC windows and external finishes should be used;</li> <li>• Use of plastic or metal alternatives to chipboard or MDF;</li> <li>• Use of concrete ground bearing slab as opposed to a suspended floor to avoid water entry beneath the floor structure;</li> <li>• Partition walls should be constructed such that replacement is not required following a flood event;</li> <li>• Underfloor services using ferrous metals will be avoided where practicable;</li> <li>• Use of self-closing airbricks or air brick covers;</li> <li>• Waterproof pointing to any brickwork;</li> <li>• Inclusion of liquid DPMs over floor screeds; and,</li> <li>• Use of full cell insulation in all walls and floors instead of fibre.</li> </ul> </li> <li>• The detailed design of the development will make an allowance for flow routing from rainfall events in exceedance of the drainage design capacity (i.e. the 100 year plus 40% climate change) in accordance with best practice guidance;</li> <li>• External areas will also be profiled so as any runoff will be directed away from dwellings and into the roads and designated open space areas;</li> <li>• Appropriate maintenance of downstream riparian watercourses, culverts and main rivers by the respective riparian owners and EA.</li> </ul>	Will ensure flood risk from this source is minimised for the lifetime of the development and as updated modelling becomes available, whilst also ensuring no downstream impacts arise from new structures within the flood zone.	Low
Flooding from perched/shallow groundwater	Perched or Shallow groundwater may be present or may affect the site in the future during periods of prolonged extreme rainfall, due to the increasing effects of climate change (for rainfall above the design event). This may result in flooding of the internal building in extreme cases.	<ul style="list-style-type: none"> <li>• Consider the need for groundwater monitoring</li> <li>• Consider the need for dewatering during the construction phase.</li> <li>• Consider the need for waterproofing substructures and any below ground services as part of the detailed design.</li> <li>• Carry out de-watering as necessary through the construction phase.</li> <li>• Where surface and foul water drainage networks are to be placed within any water bearing strata, they should be constructed such that water ingress cannot occur.</li> </ul>	Will ensure the risk of flooding and moisture ingress is minimised.	Low

Type of Flooding (Source)	Issue	Mitigation Measures	Justification	Residual Risk *
Flooding from failure of water mains associated with existing assets (external water supply system)	A residual risk of flooding associated with burst water mains may result in flooding of open areas, access roads and dwellings.	<ul style="list-style-type: none"> <li>All water mains within development areas will be suitably located and marked prior to the commencement of construction to minimise the risk of strikes during excavation works.</li> </ul>	Will ensure the residual risk is minimised for the lifetime of the development.	Low
Flooding from proposed water mains (proposed internal water supply system).	A residual risk of flooding associated with internal water supply and distribution systems may result in flooding of dwellings.	<ul style="list-style-type: none"> <li>Routine inspection of the Site and public water supply and distribution system by the Site owner and Essex and Suffolk Water.</li> </ul>	Will ensure the residual risk is minimised for the lifetime of the development.	Low
Sewer flooding from existing public and private drainage (foul and surface water).	Blockages or surcharges in the Site drainage or the public sewer network crossing the Site or in the Site vicinity may result in flooding of the Site.	<ul style="list-style-type: none"> <li>Maintain an appropriate 6.0 m easement around the foul water sewer and surface water sewer crossing the site and allow appropriate easement within detailed design for future connections;</li> <li>Diversion of assets will be carried out, if needed, with the agreement of AW or appropriate buildover agreements entered.</li> <li>Confirm capacity is still available in the public sewer network at the detailed design stage;</li> <li>Where connections are proposed to the existing foul sewer network, required upgrades will be carried out prior to the occupation of the relevant development areas, to ensure suitable capacity is available.</li> </ul>	In the event of foul and surface water flooding occurring, these measures will ensure the effects of flooding to external areas and dwellings will be minimised.	Low
	A residual risk of flooding associated with the blockage/surcharge or failure of existing foul and surface water drainage networks remains.	<ul style="list-style-type: none"> <li>All sewers within development areas will be suitably located and marked prior to the commencement of construction to minimise the risk of strikes during excavation works.</li> <li>Floor levels of dwellings will be raised above the surrounding area as above.</li> <li>At the detailed design stage consideration will be given to flood flow routes in the event of a system surcharge/blockage, these will ensure any surcharged water is kept within kerb line and away from properties and all access points.</li> <li>Consider opportunities for flood resilient design as above.</li> <li>Ensure routine inspection and maintenance of both the on-site and offsite drainage systems by the Site management and AW;</li> <li>A management plan for the maintenance of drainage assets should be prepared and agreed with appropriate authorities as part of the detailed design. This should ensure routine inspection and maintenance of both the foul and surface water drainage systems by the Site management and/or any adopting body and AW;</li> </ul>	Will ensure the risk of flooding is minimised as far as possible including as part of the detailed design stage	
Increased flood risk to surrounding and downstream properties and land as a result of the increased impermeable area associated with the scheme.	The scheme will change surface water run-off rates and patterns which may increase risk of flooding to neighbouring land or property, most notably due to the increase in runoff volume.	<ul style="list-style-type: none"> <li>Sustainable drainage systems and surface water attenuation will be included to ensure the risk of flooding to the surrounding area is minimised whilst no flooding of properties occurs during the design 1 in 100-year surface water flood plus 40% climate change event. Associated with this is the restriction of flows to the equivalent 1 in 1-year greenfield runoff rate for all impermeable areas, as outlined in Chapter 5.</li> <li>The detailed design of the development will make an allowance for flow routing from rainfall events in exceedance of the drainage design capacity (i.e. the 100 year plus 40% climate change) in accordance with best practice guidance to ensure surcharged flows are directed, above ground and within roadways or open space, towards the permeable paving.</li> <li>At the detailed design stage consideration will also be given to flood flow routes in the event of a system surcharge/blockage, these will ensure any surcharged water is kept within kerb line and away from properties.</li> <li>External areas will also be profiled so as any runoff will be directed away from dwellings, into roadways/open space and towards permeable paving.</li> <li>Maintenance plans and schedules will be compiled for all sustainable drainage systems in the scheme at the detailed design stage. These should ensure routine inspection and maintenance of both the foul and surface water drainage systems and will be targeted towards all responsible parties including homeowners, adopting authorities and private management companies. These measures will ensure the effective operation of all drainage assets for the lifetime of the development.</li> <li>Appropriate maintenance of downstream sewers by AW and of any downstream culverts by the respective riparian owners.</li> <li>Floor levels of all units will be raised above the surrounding area as above.</li> </ul>	These measures will ensure the risk of flooding posed by the development will be reduced in line with the design standard, whilst events in excess of this are suitably managed where possible, in line with local and national policy requirements.	Low

Type of Flooding (Source)	Issue	Mitigation Measures	Justification	Residual Risk *
	The development of the Site will increase foul water flows in the local network.	<ul style="list-style-type: none"> <li>• AW will be consulted further at the detailed design stage to confirm network capacity.</li> <li>• The existing site network, where connections are proposed, will be upgraded, where necessary, in liaison with AW.</li> <li>• Routine inspection and maintenance of both the foul water drainage systems private owners, management companies and the adopting authority.</li> <li>• Confirm Foul Water connection point and agree appropriate diversion/buildover of foul sewer crossing the Site at the detailed design stage;</li> <li>• Confirm Foul Water connection point with AW and adjacent site owner should the immediate connection be private at the detailed design stage.</li> </ul>		
	The introduction of new water mains to supply the development has the potential to increase the residual risk of bursts associated with these structures	<ul style="list-style-type: none"> <li>• Appropriate easements will be maintained around all proposed water mains and placed, where possible, within main service corridors beneath roadways. This will ensure that any flood waters are contained within kerb lines and channelled towards permeable paving as per the above flow routing requirements.</li> </ul>		

**Table 7.1. Mitigation Measures**

\*Following adoption of the mitigation measures



## **8.0 RESIDUAL FLOOD RISKS AND IMPACTS TO SURROUNDING AREAS**

### **Residual Risks**

- 8.1 A number of residual risks have been identified, associated with surface water flooding, public sewers, shallow groundwater site drainage and water supply pipes and intense rainfall.
- 8.2 As long as the mitigation measures outlined in Table 7.1 are adopted then then the residual risks will be minimised as far as possible.

### **Impact on Flood Risk of Surrounding Areas**

- 8.3 Given the generally low flood risk present on site and the drainage strategy proposed, it is considered that the development of the Site will not increase the risk of flooding in other areas, surrounding the Site, assuming the measures proposed in Table 7.1 are implemented. Obviously a risk of surface water flooding remains however the placement of the dwellings is not seen to produce a significant difference to the existing garaging and therefore it is considered that no material impact on surface water flood volumes will be observed.

## **9.0 CONCLUSIONS AND RECOMMENDATIONS**

- 9.1 Based on our understanding of the Site setting and the development proposals, it is considered that the risk of flooding from all sources is generally low, and the development can be operated safely and without significantly increasing flood risk elsewhere. A risk of surface water flooding remains, however appropriate mitigation measures have been proposed. A number of residual risks have also been identified, associated with public sewers, site drainage, water supply pipes, intense rainfall, surface water flooding, and groundwater flooding. Appropriate mitigation measures have been provided in Table 7.1 to address and manage the residual risk from these forms of flooding.
- 9.2 We recommend that the assessment of risks and residual risks should be reviewed by site owners as new flood risk information becomes available, and the flood risk associated with adjacent sewers may also increase over time in the area due to climate change.

---

## 10.0 REFERENCES

- i. British Geological Survey Geoindex (2017). Available at: [www.bgs.ac.uk/geoindex](http://www.bgs.ac.uk/geoindex).
- ii. Environment Agency Surface Water Flood Maps and Reservoir Flood Maps (2014). Available at: <https://flood-warning-information.service.gov.uk/long-term-flood-risk/>. (Accessed December 2022).
- iii. Government Flood Map for Planning and Groundwater Maps (2017). Available at: <https://flood-map-for-planning.service.gov.uk/>. (Accessed December 2022).
- iv. Chelmsford City Council (2018) *Chelmsford Draft Local Plan Pre-Submission Document (Regulation 19 - Publication Draft)*.
- v. Chelmsford City Council (2008) *Chelmsford Adopted Local Plan – Core Strategy and Development Control Policies*.
- vi. Chelmsford City Council (2013) *Chelmsford Adopted Local Plan – Core Strategy and Development Control Policies Focused Review*.
- vii. JBA Consulting (2018) *Chelmsford City Council Strategic Flood Risk Assessment (SFRA) Level 1 and 2*.
- viii. Capita Symonds (2014) *Chelmsford Surface Water Management Plan*.
- ix. Chelmsford City Council (2018) *Chelmsford City Water Cycle Study Update*.
- x. Water UK/WRc plc (2012) *Sewers for Adoption – 7th Edition*. WRc plc, Swindon.
- xi. Woods-Ballard., et al. (2015) *The SUDS Manual*. Report C753. CIRIA, London.
- xii. Essex County Council (2011) *Preliminary Flood Risk Assessment*. URS, Scott Wilson.
- xiii. Essex County Council (2013) *Local Flood Risk Management Strategy*. Capita Symonds, Essex County Council.
- xiv. Essex County Council (20XX) *The SUDS Design Guide*. [Online] Essex County Council.

# FIGURES



NOTES:  
1. BASED ON SITE BOUNDARY AND GOOGLE EARTH IMAGERY (ACCESSED SEPTEMBER, 2022).

KEY:  
 Site Location

FIGURE TITLE:  
1.1 SITE LOCATION PLAN



Create Consulting Engineers Ltd. accept no responsibility for any unauthorised amendments to this figure. Only figured dimensions are to be worked to. COPYRIGHT © RESERVED.

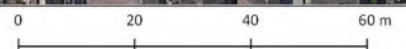

[www.createconsultingengineers.co.uk](http://www.createconsultingengineers.co.uk)

Figure 1.1: Site Location Plan

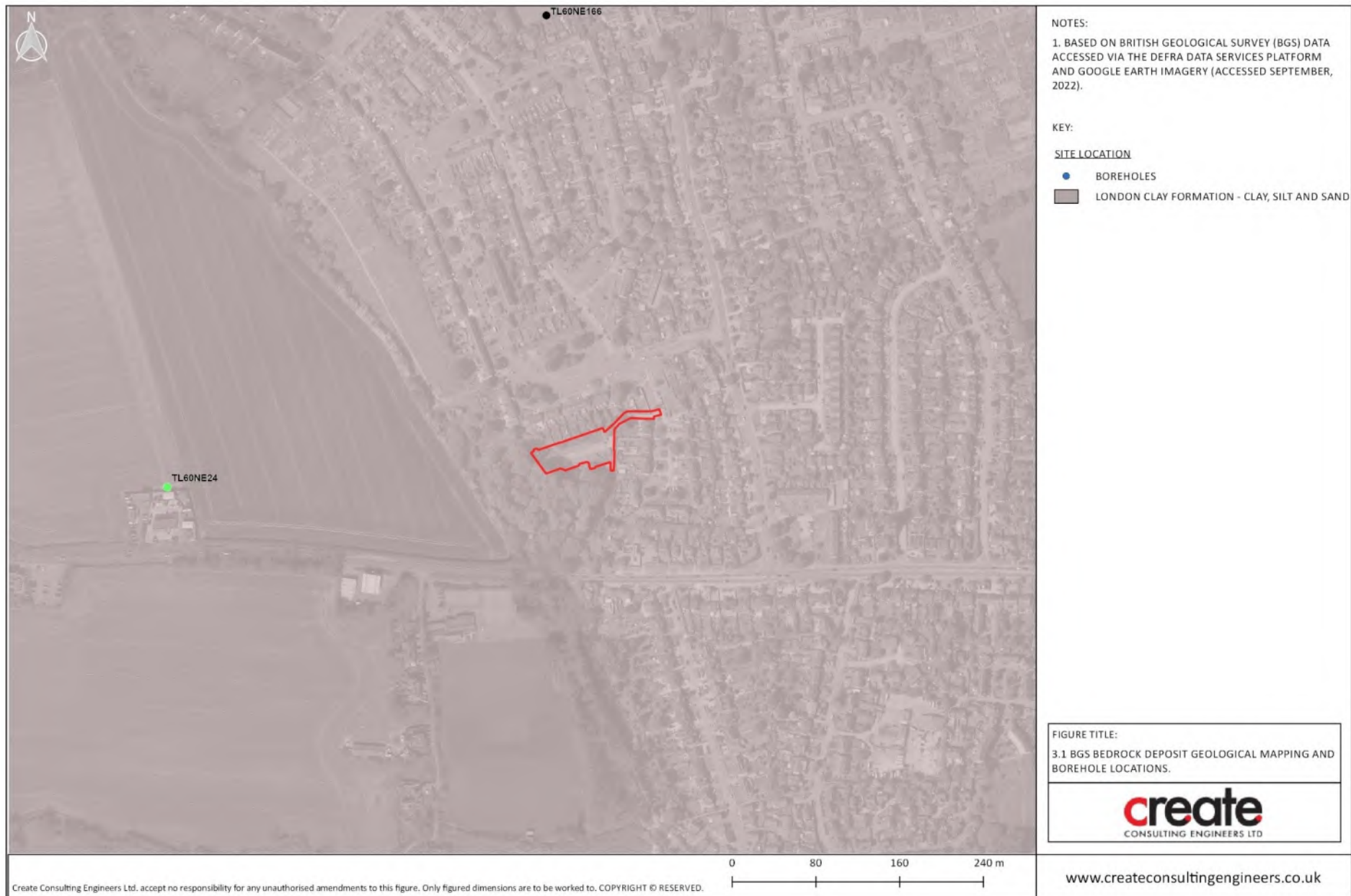

**Figure 3.1: British Geological Survey Bedrock Geology Mapping Extract (1:50,000 scale)**



**Figure 3.2: British Geological Survey Superficial Geology Mapping Extract (1:50,000 scale)**



NOTES:  
 1. SOURCED FROM ENVIRONMENT AGENCY (EA) MAPPING DATA ACCESSED VIA THE DEFRA DATA SERVICES PLATFORM AND GOOGLE EARTH IMAGERY (ACCESSED SEPTEMBER, 2022).

KEY:  
 SITE LOCATION  
 — STATUTORY MAIN RIVER  
 — KNOWN WATERCOURSE

FIGURE TITLE:  
 3.3 IDENTIFIED LOCAL WATERCOURSES



[www.createconsultingengineers.co.uk](http://www.createconsultingengineers.co.uk)

Create Consulting Engineers Ltd, accept no responsibility for any unauthorised amendments to this figure. Only figured dimensions are to be worked to. COPYRIGHT © RESERVED.

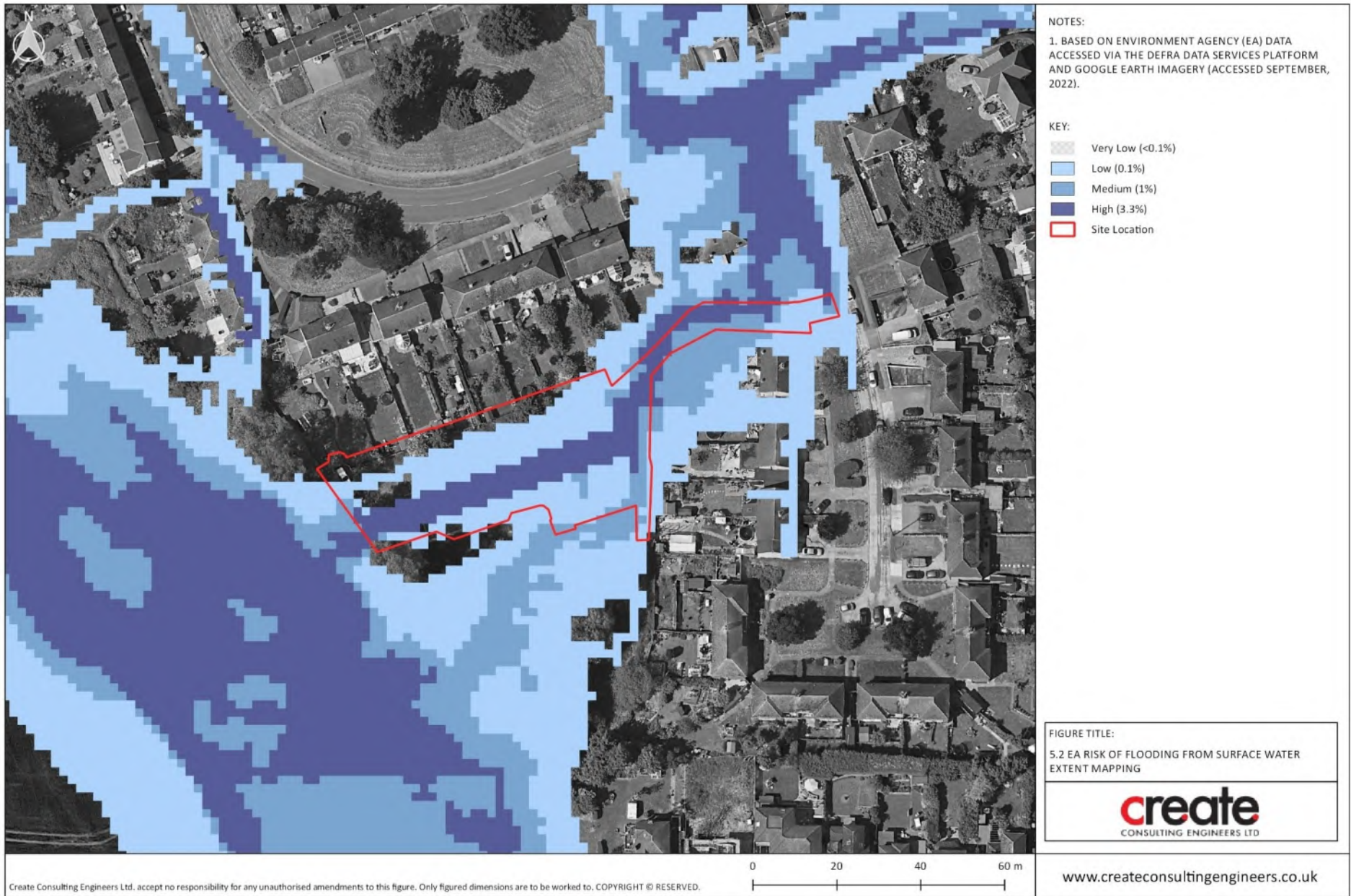

**Figure 3.3: Identified Local Watercourse Map**





**Figure 5.1: Environment Agency Fluvial/Tidal Flood Map**



**Figure 5.2: Environment Agency Surface Water Flood Risk Map**

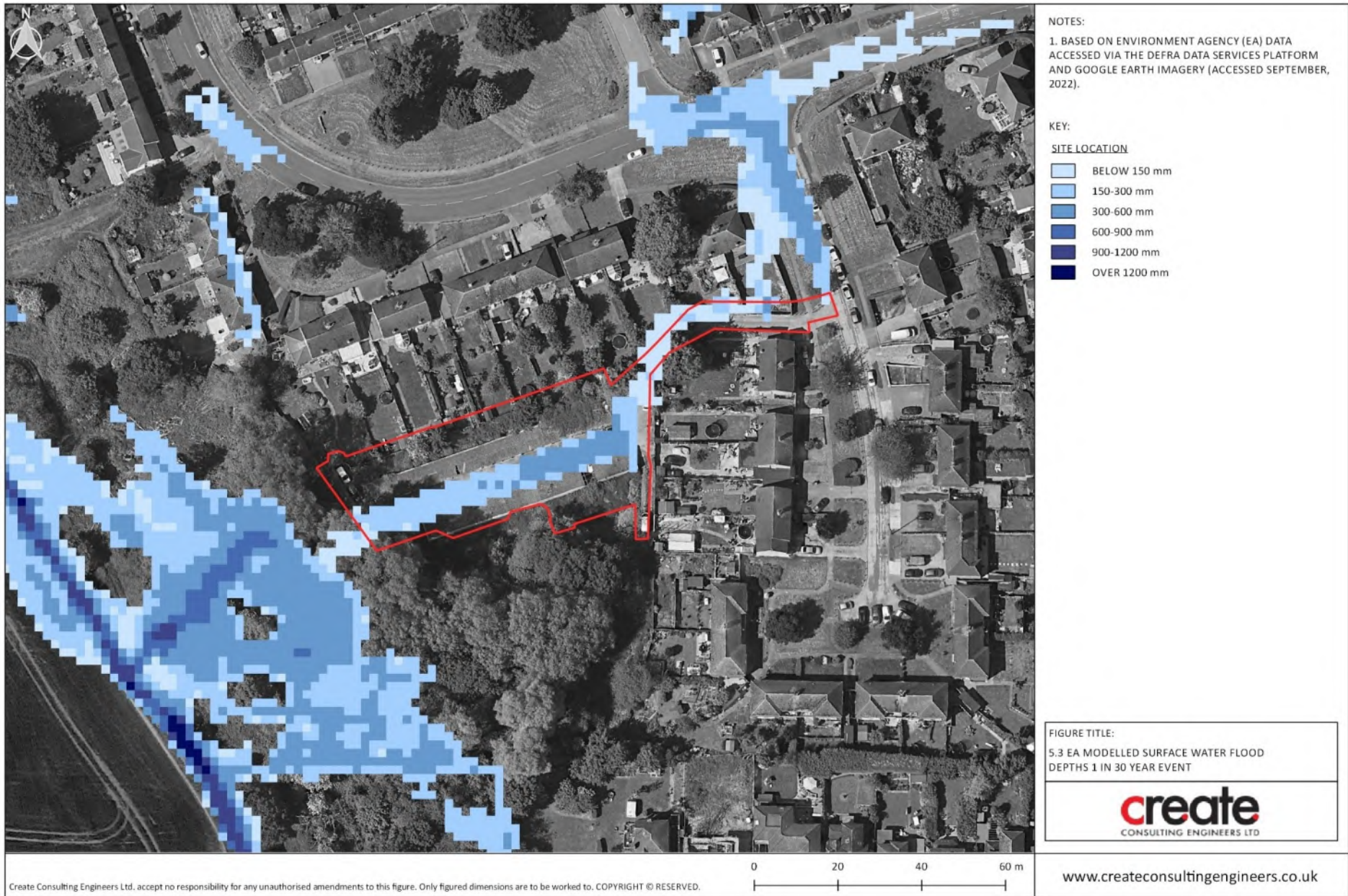
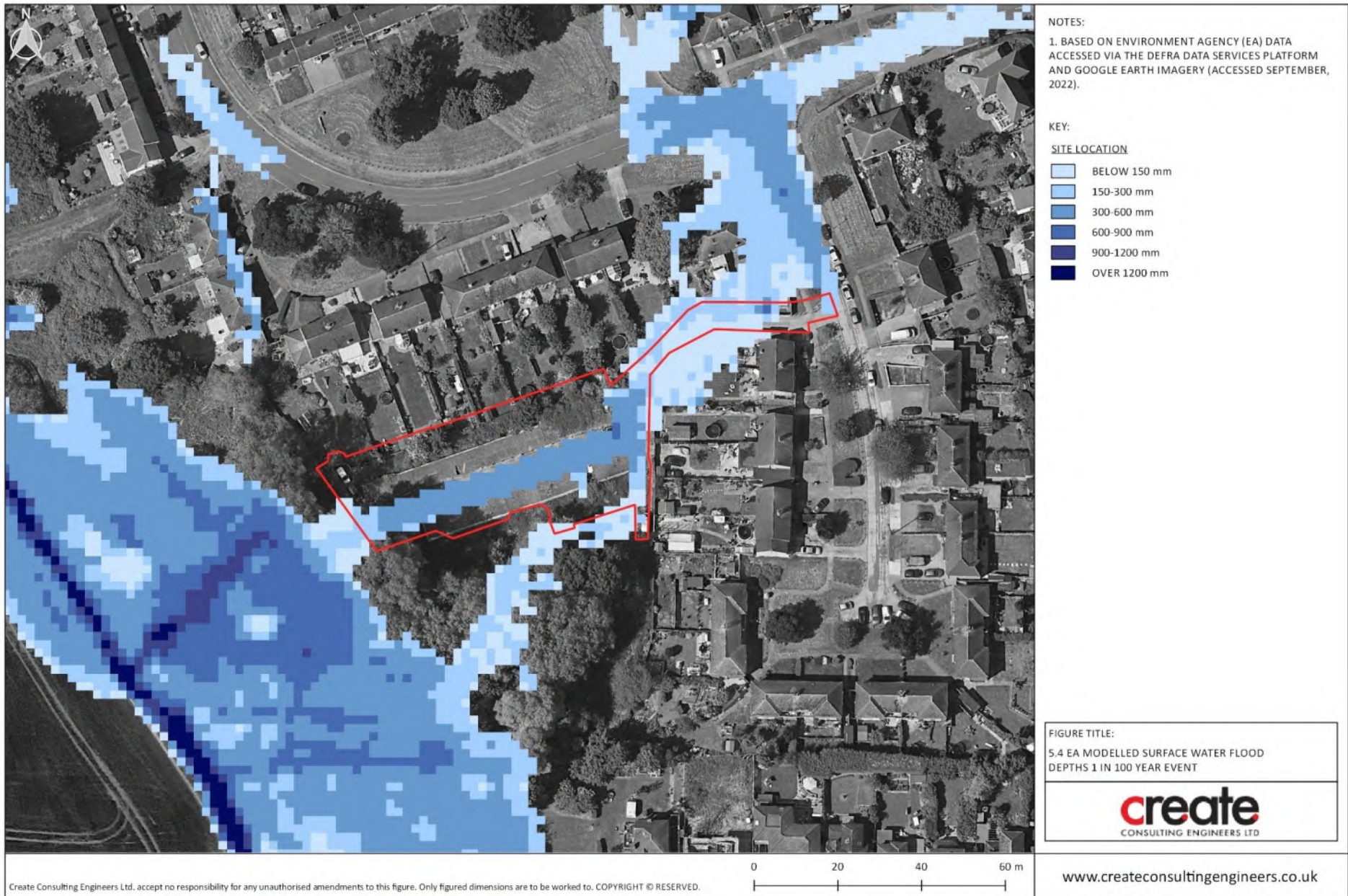
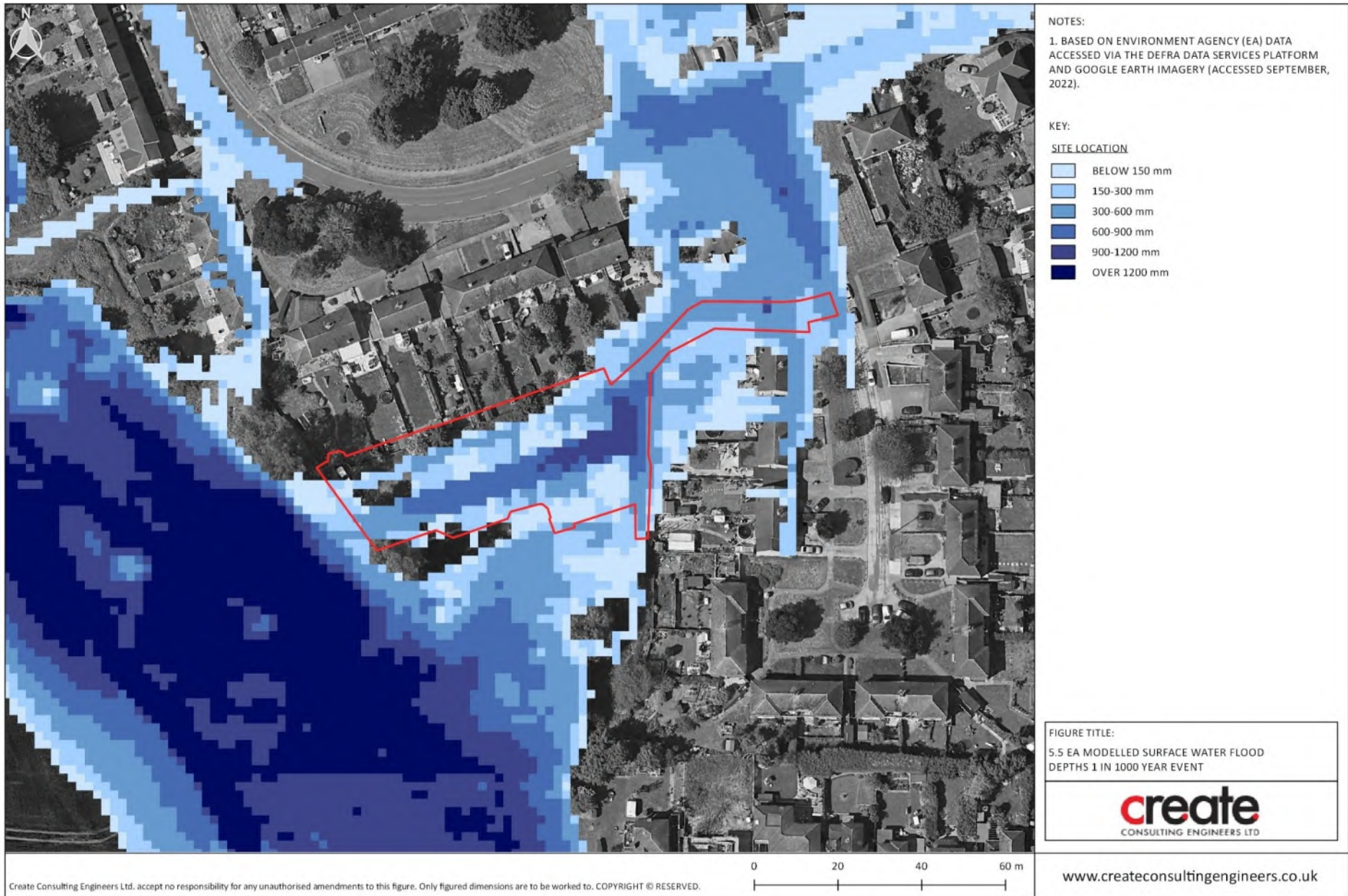

Figure 5.3: Environment Agency Surface Water Flood Depth Map 3.3%



**Figure 5.4: Environment Agency Surface Water Flood Depth Map 1% Event**



**Figure 5.5: Environment Agency Surface Water Flood Depth Map 0.1% Event**



**Figure 5.6: Environment Agency Risk of Flooding from Reservoirs Map**

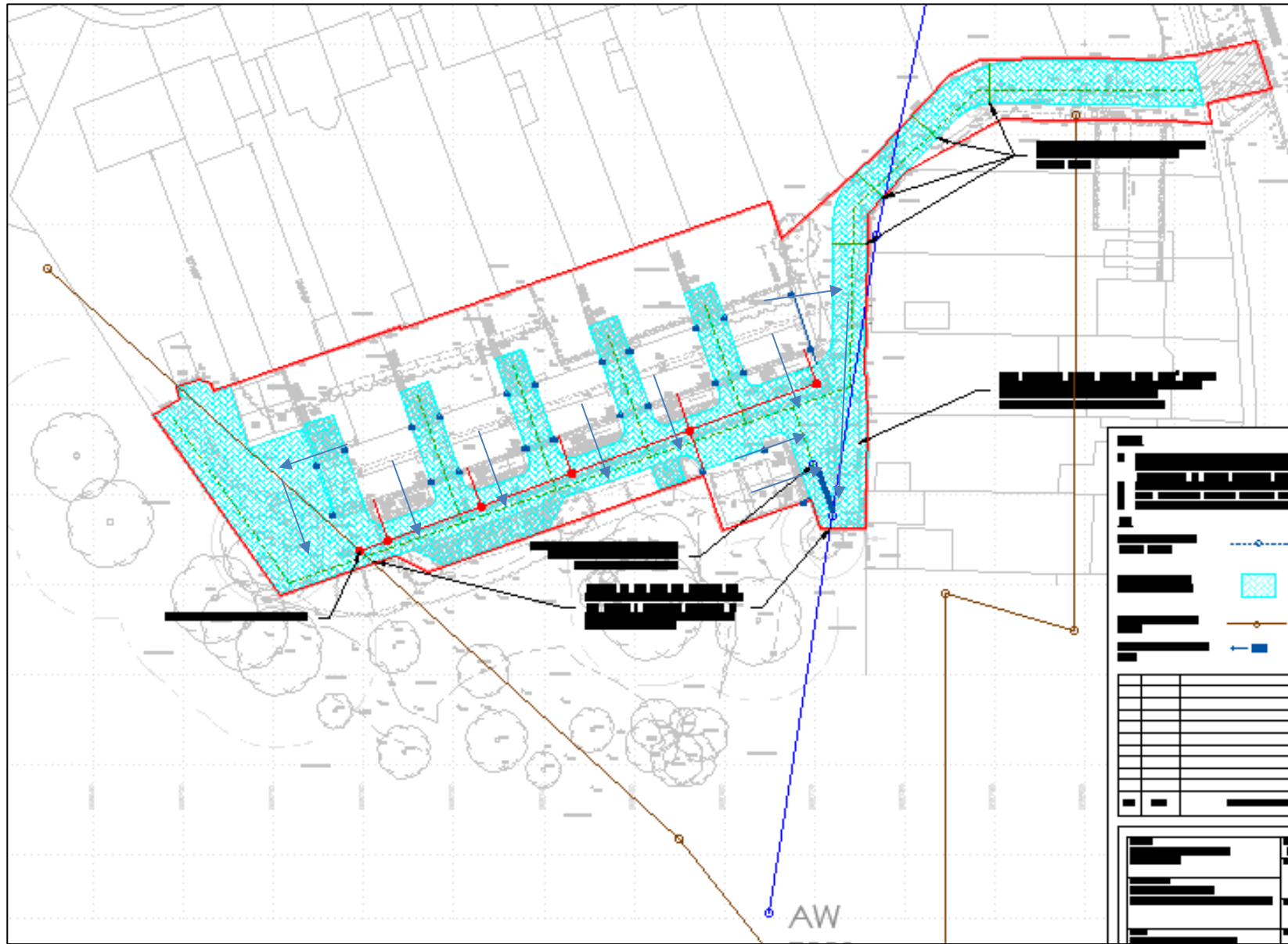

Figure 6.1: Indicative Exceedance Routes

Source: Drawing XXXXX by XXXX

# APPENDICES



# APPENDIX A

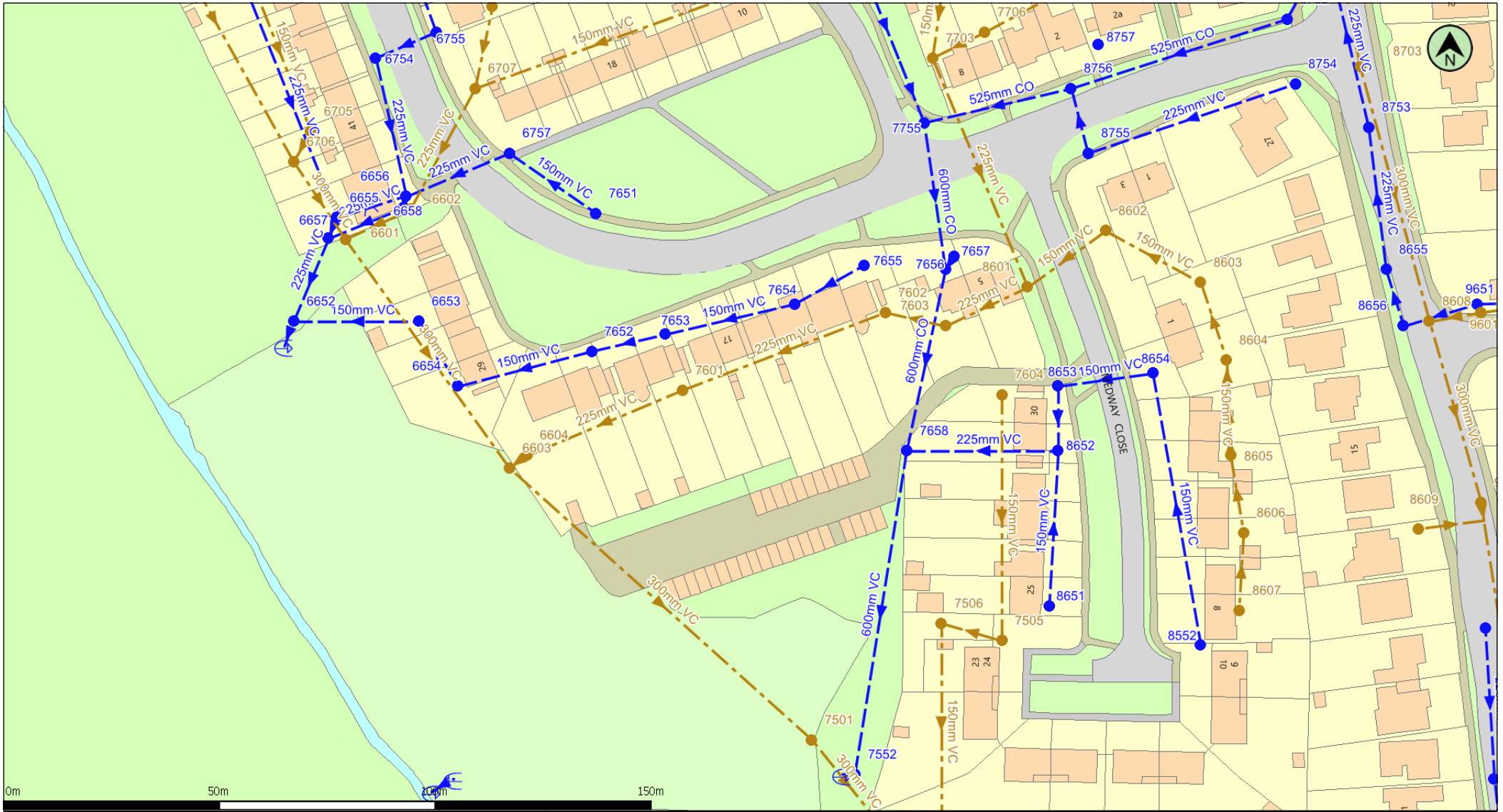

(c) Crown copyright and database rights 2022 Ordnance Survey 100022432      Date: 26/09/22      Scale: 1:1250      Map Centre: 568741,207649      Data updated: 31/08/22      Our Ref: 960195 - 3      Wastewater Plan A4

This plan is provided by Anglian Water pursuant its obligations under the Water Industry Act 1991 sections 198 or 199. It must be used in conjunction with any search results attached. The information on this plan is based on data currently recorded but position must be regarded as approximate. Service pipes, private sewers and drains are generally not shown. Users of this map are strongly advised to commission their own survey of the area shown on the plan before carrying out any works. The actual position of all apparatus MUST be established by trial holes. No liability whatsoever, including liability for negligence, is accepted by Anglian Water for any error or inaccuracy or omission, including the failure to accurately record, or record at all, the location of any water main, discharge pipe, sewer or disposal main or any item of apparatus. This information is valid for the date printed. This plan is produced by Anglian Water Services Limited (c) Crown copyright and database rights 2022 Ordnance Survey 100022432. This map is to be used for the purposes of viewing the location of Anglian Water plant only. Any other uses of the map data or further copies is not permitted. This notice is not intended to exclude or restrict liability for death or personal injury resulting from negligence.

Foul Sewer	--- (dashed brown)	Outfall*	⊕	Sewage Treatment Works	□ (red outline)
Surface Sewer	--- (dashed blue)	Inlet*	⊕	Public Pumping Station	● (red)
Combined Sewer	--- (dashed red)	Rising Main*	⊕	Decommissioned Pumping Station	● (black)
Final Effluent	--- (dashed pink)	Private Sewer*	⊕		
Rising Main*	--- (dashed black)	Decommissioned Sewer*	⊕		
Private Sewer*	--- (dashed black)	Manhole*	● (black)		
Decommissioned Sewer*	--- (dashed black)				

\* (Colour denotes effluent type)

claire.seymour@createconsultingengineers.co.uk

P22-2709 Chelmsford



Manhole Reference	Liquid Type	Cover Level	Invert Level	Depth to Invert
6601	F	29.82	27.32	2.5
6602	F	30.85	28.53	2.32
6603	F	29.97	27.2	2.77
6604	F	30.77	27.75	3.02
6705	F	-	-	-
6706	F	-	-	-
6707	F	31.82	29.91	1.91
6708	F	32.51	30.5	2.01
7501	F	28.07	26.94	1.13
7505	F	30.85	28.21	2.64
7506	F	30.2	27.96	2.24
7601	F	31.68	27.95	3.73
7602	F	31.42	28.22	3.2
7603	F	30.82	28.33	2.49
7604	F	30.92	29.35	1.57
7703	F	32.35	29.56	2.79
7706	F	32.4	29.98	2.42
8601	F	30.81	28.44	2.37
8602	F	31.15	29.53	1.62
8603	F	32.3	29.94	2.36
8604	F	32.54	29.98	2.56
8605	F	33.41	32.12	1.29
8606	F	33.66	32.62	1.04
8607	F	33.71	33.19	0.52
8608	F	35.04	31.13	3.91
8609	F	-	-	-
8703	F	33.47	31.56	1.91
9601	F	35.62	33.29	2.33
9613	F	34.9	30.91	3.99
6652	S	28.47	27.87	0.6
6653	S	29.99	27.92	2.07
6654	S	30.07	-	-

Manhole Reference	Liquid Type	Cover Level	Invert Level	Depth to Invert
6655	S	29.98	28.16	1.82
6656	S	30.89	29.02	1.87
6657	S	-	-	-
6658	S	-	-	-
6754	S	31.24	29.9	1.34
6755	S	31.73	30.31	1.42
6757	S	31.61	29.83	1.78
7552	S	27.7	26.26	1.44
7651	S	31.59	30.24	1.35
7652	S	30.92	29.31	1.61
7653	S	31.41	29.73	1.68
7654	S	31.65	30.25	1.4
7655	S	31.45	30.61	0.84
7656	S	30.88	28.83	2.05
7657	S	30.98	29.35	1.63
7658	S	29.57	28.17	1.4
7755	S	31.74	29.78	1.96
8552	S	33.05	-	-
8651	S	31.11	30.06	1.05
8652	S	30.89	29.5	1.39
8653	S	31.04	29.99	1.05
8654	S	32.12	30.65	1.47
8655	S	34.59	33.36	1.23
8656	S	35.03	33.56	1.47
8752	S	32.77	30.72	2.05
8753	S	33.86	32.25	1.61
8754	S	32.73	30.78	1.95
8755	S	31.34	30.25	1.09
8756	S	31.48	29.82	1.66
8757	S	-	-	-
9554	S	34.46	32.95	1.51
9561	S	-	-	-

Manhole Reference	Liquid Type	Cover Level	Invert Level	Depth to Invert
9651	S	35.63	33.68	1.95

Manhole Reference	Liquid Type	Cover Level	Invert Level	Depth to Invert

## **APPENDIX B**

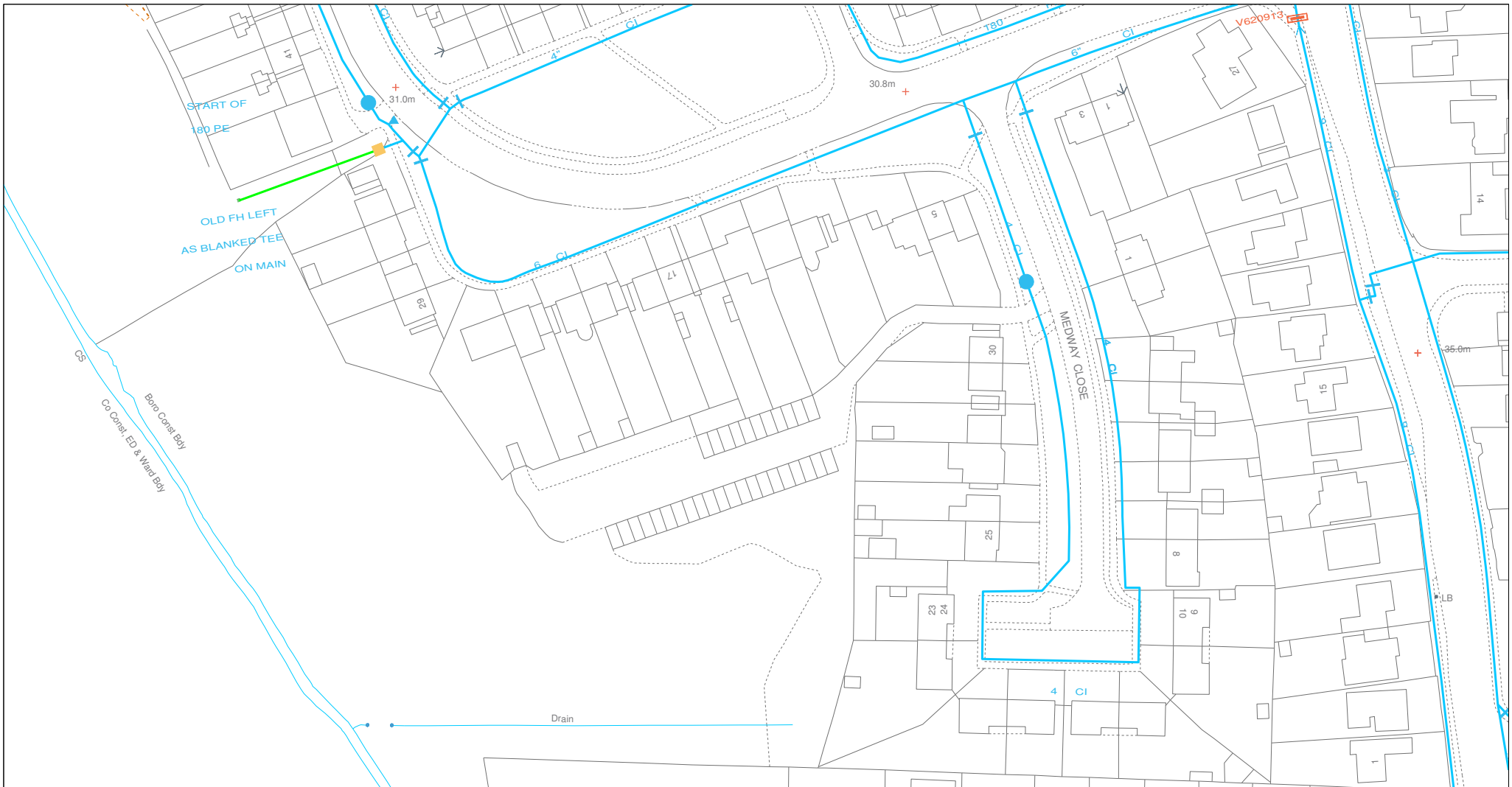

Valves/Regulators	Fittings/Symbols	Storage/Operations	Network Types	Specific Main Types	Area Types
			Distribution  Fire  Abandoned Asbestos Treated  Supply  Abandoned Raw  Out of Commission	Private Proposed District Metering	Water Quality District Metering Easement 



User : OLIVA  
Title : 0000

Date : 03/10/2022  
Centre Point : 568754,207638

Map Sheet : TL6807NE

The material contained on this plot has been reproduced from an Ordnance Survey map with permission of the controller of H.M.S.O. Crown Copyright Reserved. Licence No. 100022480. The information shown on this plan should be regarded as approximate and is intended for guidance only. No Liability of any kind whatsoever is accepted by Essex & Suffolk Water, its servants or agents for any omission. The actual position of any mains shown on the plan must be established by taking trial holes in all cases. Essex & Suffolk Water must be given two working days notice of their intention to excavate trial holes. Private connections are not shown but their presence should be anticipated. **WARNING...** Where indicated on the plan there could be abandoned asbestos cement materials or shards of pipe. If excavating in the vicinity of these abandoned asbestos cement materials, the appropriate Health & Safety precautions should be taken. Essex & Suffolk Water accepts no liability in respect of claims, costs, losses or other liabilities which arise as the result of the presence of the pipes or any failure to take adequate precautions. Emergency Telephone Number: 0345 782 0999



## **APPENDIX C**

## Vicky Luck

---

**From:** George Baker  
**Sent:** 01 December 2022 16:04  
**To:** planningliason@anglianwater.co.uk  
**Subject:** P22-2709 - Rectory Lane, Glebe Road and Medway Close Car Parks, Chelmsford (plus St Michaels Drive and East Hanningfield Sites No.1 and No.2)  
**Attachments:** 2809\_02\_005 Preliminary Surface Water Drainage Strategy (i) (St Michaels Drive).pdf; 2709\_02\_004 Preliminary Foul and Surface Water Drainage Strategy (i) (Medway Close).pdf; 2709\_02\_001 Preliminary Surface Water Drainage Strategy (ii).pdf; RE: PPE-0142790-Decoy Road; 960195\_A4\_Wastewater Site 4.pdf; 960195\_A4\_Wastewater Site 3.pdf; 960195\_A4\_Wastewater Sites 5 and 6.pdf

Hi!

George Baker here from Create Consulting Engineers. We're currently undertaking the Foul and Surface Water drainage strategies for several Chelmsford sites for Chelmsford City Council.

I am contacting the planning liaison directly as four of the sites we've been allocated have less than 10 residential dwellings.

In line with AW guidance, as attached in the email correspondence with Sandra Olim, this should mean that we just have to submit a s106 application to connect instead of having to submit a full Pre planning enquiry.

Can AW confirm that this would be the case for our sites?

Below is a summary of the proposed drainage strategies for the sites:

### East Hanningfield Site: south

**Surface Water:** The surface water flows from the 1 dwelling are proposed to be stored in tanked permeable paving, then be discharged via a flow control hydrobrake at 1.0l/s. This will then connect to AW manhole 8959 (NGR 576867 200929) via gravity.

**Foul Water:** The Foul Water flows from the 1 dwelling are proposed to drain via gravity to AW manhole 8901 (NGR 576869 200913)

### East Hanningfield Site: west

**Surface Water:** The surface water flows from the 3 dwellings are proposed to be stored in tanked permeable paving, then be discharged via a flow control hydrobrake at 1.0l/s. This will then connect to AW manhole 8953 (GR 576817 200927) via gravity.

**Foul Water:** The Foul Water flows from the 3 dwellings are proposed to drain via gravity to AW manhole 8905 (NGR 576825 200929)

### Medway Close

**Surface Water:** The surface water flows from the 6 dwellings are proposed to be stored in tanked permeable paving, then it will discharge via a flow control hydrobrake at 1.0l/s. This will then connect to the AW network on the pipe run to the east of the site at a new connection or at manhole 7552 (NGR 568765 207563) via gravity.

**Foul Water:** Currently there is a foul water sewer crossing the western side of the Site. It is proposed that we connect to either a new connection on the pipe run or to AW manhole 7501 (NGR 568755 207571)

### St Michaels Drive

**Surface Water:** The surface water for the site is not connecting to the AW network as there are no surface water sewers in the vicinity of the site.



**Foul Water:** There are foul water assets in the eastern footway of medway close, it is assumed that the site will drain via gravity to AW manhole 4505.

Kind Regards,

George Baker  
Graduate Flood Risk Consultant

**Create Consulting Engineers Ltd**  
15 Princes Street | Norwich | NR3 1AF  
T 01603 877 010



Create Consulting Engineers Ltd is a registered company in England and Wales No. 6830694  
Registered Office: 25 Church Close, South Walsham, Norwich, NR13 6DW

## **APPENDIX D**

Location : **Medway Close, Chelmsford**

M5-60 : 20 mm  
r : 0.45

Wallingford Method - maps

**For different durations,**

From Table 1

Duration, D	Z1			
15 min	0.65	<b>M5-15:</b>	Z1 x M5-60	13.00 mm
30 min	0.82	<b>M5-30:</b>	Z1 x M5-60	16.40 mm
60 min	1	<b>M5-60:</b>	Z1 x M5-60	20.00 mm
6hr	1.51	<b>M5-360:</b>	Z1 x M5-60	30.20 mm

**For different return intervals,**

From Table 2\*

Duration, D	M1	Z2	M30	M100
15 min	0.62	1.52	1.96	1.96
30 min	0.62	1.53	2.00	2.00
60 min	0.64	1.54	2.03	2.03
6 hr	0.68	1.51	1.97	1.97

**Average point intensity, API = I/(D/60)**

	D min	Calculation	i mm	API mm/hr
M 1-15	15	M5-15*Z2(M1)	8.06	32.24
M 1-30	30	M5-30*Z2(M1)	10.17	20.34
M 1-60	30	M5-360*Z2(M1)	12.80	25.60
M1-360	360	M5-360*Z2(M1)	20.54	3.42
M 30-15	15	M5-15*Z2(M30)	19.76	79.04
M 30-30	30	M5-30*Z2(M30)	25.09	50.18
M 30-60	60	M5-60*Z2(M30)	30.80	30.80
M30-360	360	M5-360*Z2(M30)	45.60	7.60
M 100-15	15	M5-15*Z2(M100)	25.48	101.92
M 100-30	30	M5-30*Z2(M100)	32.80	65.60
M100-60	60	M5-60*Z2(M100)	40.60	40.60
M100-360	360	M5-360*Z2(M100)	59.49	9.92

**Peak Runoff**

Q=2.78CiA Rational Method, SUDS Manual Section 4.3.3

where: (1) C = Cv Cr

Cv = 1  
Cr = 1.3  
C = 1.3

therefore,

(2) i = API, defined above

(3) A = areas measured for subcatchments

Q=2.78CiA

	i mm/hr	Contributing Impermeable Area Ha	
		Site	Per hectare
		0.2044	1
M 1-15	32.24	23.82	116.52
M 1-30	20.34	15.02	73.49
M 1-60	25.60	18.91	73.49
M1-360	3.42	2.53	12.37
M 30-15	79.04	58.39	285.65
M 30-30	50.18	37.07	181.36

	i mm/hr	Contributing Impermeable Area Ha	
		Site	Per hectare
		0.2044	1
M 30-60	30.80	22.75	181.36
M30-360	7.60	5.61	27.47
M 100-15	101.92	75.29	368.34
M 100-30	65.60	48.46	237.08
M 100-60	40.60	29.99	237.08
M100-360	9.92	7.32	35.84

Table 1

Minutes r	Rainfall Duration D											
	5	10	15	30	1	2	4	6	10	24		
0.12	0.22	0.34	0.45	0.67	1.00	1.48	2.17	2.75	3.70	6.00		
0.15	0.25	0.38	0.48	0.69	1.00	1.42	2.02	2.46	3.32	4.90		
0.18	0.27	0.41	0.51	0.71	1.00	1.36	1.86	2.25	2.86	4.30		
0.21	0.29	0.43	0.54	0.73	1.00	1.33	1.77	2.12	2.62	3.60		
0.24	0.31	0.46	0.56	0.75	1.00	1.30	1.71	2.00	2.40	3.35		
0.27	0.33	0.48	0.58	0.76	1.00	1.27	1.64	1.88	2.24	3.10		
0.30	0.34	0.49	0.59	0.77	1.00	1.25	1.57	1.78	2.12	2.84		
0.33	0.35	0.50	0.61	0.78	1.00	1.23	1.53	1.73	2.04	2.60		
0.36	0.36	0.51	0.62	0.79	1.00	1.22	1.48	1.67	1.90	2.42		
0.39	0.37	0.52	0.63	0.80	1.00	1.21	1.46	1.62	1.82	2.28		
0.42	0.38	0.53	0.64	0.81	1.00	1.20	1.42	1.57	1.74	2.16		
0.45	0.39	0.54	0.65	0.82	1.00	1.19	1.38	1.51	1.68	2.03		

Table 2 - England and Wales

M5 rainfall	Growth Factor Z2										
	M1	M2	M3	M4	M5	M10	M20	M50	M100	M30 interpolated	
5.00	0.62	0.79	0.89	0.97	1.02	1.19	1.36	1.56	1.79	1.25	
10.00	0.61	0.79	0.90	0.97	1.03	1.22	1.41	1.65	1.91	1.49	
15.00	0.62	0.80	0.90	0.97	1.03	1.24	1.44	1.70	1.99	1.53	
20.00	0.64	0.81	0.90	0.97	1.03	1.24	1.45	1.73	2.03	1.54	
25.00	0.66	0.82	0.91	0.97	1.03	1.24	1.44	1.72	2.01	1.53	
30.00	0.68	0.83	0.91	0.97	1.03	1.22	1.42	1.70	1.97	1.51	
40.00	0.70	0.84	0.92	0.97	1.02	1.19	1.38	1.64	1.89	1.47	
50.00	0.72	0.85	0.93	0.98	1.02	1.17	1.34	1.58	1.81	1.42	
75.00	0.76	0.87	0.93	0.98	1.02	1.14	1.28	1.47	1.64	1.34	
100.00	0.78	0.88	0.94	0.98	1.02	1.13	1.25	1.40	1.54	1.30	
150.00	0.78	0.88	0.94	0.98	1.01	1.12	1.21	1.33	1.45	1.25	
200.00	0.78	0.88	0.94	0.98	1.01	1.11	1.19	1.30	1.40	1.23	

\* The rainfall depths from cells E8-E11 are compared with the depths given in cells J29-J40 and Z2 interpolated accordingly for each return period

\*\* Cv varies between 0.6 (rapidly draining soils) and 0.9 (heavy clay) with an average of 0.75 taken if ground conditions not known.  
2.78\*C= 3.614

## IoH 124 Calculation of Greenfield Runoff Rate

<b>Project:</b>	P22-2709 Medway Close, Chelmsford		
<b>OS Location</b>	568750	E	207628 N
<b>Date:</b>	13/10/2022		
<b>Written By:</b>	GGB	<b>Checked By:</b>	GS

<b>SAAR</b>	569	mm
<b>Pro Rata Site Area =</b>	50	ha
	0.5	km <sup>2</sup>
<b>Soil WRA Class</b>	3	
<b>Soil Type SPR Value</b>	0.4	

$$Q_{bar}_{rural} = 0.00108 \times (AREA)0.89 \times (SAAR)1.17 \times (SOIL)2.17$$

$$Q_{bar-50ha} = 0.133 \text{ m}^3/\text{s}$$

### From Regional Growth Curve Factor

Region: 6

<b>Return period</b>	1	2	5	10	25	30	50	100	500
<b>Growth Factor</b>	0.85	0.88	1.28	1.62	2.14	2.24	2.62	3.19	4.49

<b>Q<sub>1</sub> 50ha =</b>	0.113	m <sup>3</sup> /s	=	113.47	l/s	=	2.269	l/s/ha
<b>Q<sub>2</sub> 50ha =</b>	0.117	m <sup>3</sup> /s	=	117.47	l/s	=	2.349	l/s/ha
<b>Q<sub>5</sub> 50ha =</b>	0.171	m <sup>3</sup> /s	=	170.87	l/s	=	3.417	l/s/ha
<b>Q<sub>10</sub> 50ha =</b>	0.216	m <sup>3</sup> /s	=	216.26	l/s	=	4.325	l/s/ha
<b>Q<sub>25</sub> 50ha =</b>	0.286	m <sup>3</sup> /s	=	285.68	l/s	=	5.714	l/s/ha
<b>Q<sub>30</sub> 50ha =</b>	0.299	m <sup>3</sup> /s	=	299.02	l/s	=	5.980	l/s/ha
<b>Q<sub>50</sub> 50ha =</b>	0.350	m <sup>3</sup> /s	=	349.75	l/s	=	6.995	l/s/ha
<b>Q<sub>100</sub> 50ha =</b>	0.426	m <sup>3</sup> /s	=	425.84	l/s	=	8.517	l/s/ha
<b>Q<sub>500</sub> 50ha =</b>	0.599	m <sup>3</sup> /s	=	599.38	l/s	=	11.988	l/s/ha

### Factored for Development Impermeable Area

Site Area = 0.1568

<b>Q<sub>bar</sub> site =</b>	0.000	m <sup>3</sup> /s	=	0.4	l/s	=	2.7	l/s/ha
<b>Q<sub>1</sub> site =</b>	0.000	m <sup>3</sup> /s	=	0.4	l/s	=	2.3	l/s/ha
<b>Q<sub>2</sub> site =</b>	0.000	m <sup>3</sup> /s	=	0.4	l/s	=	2.3	l/s/ha
<b>Q<sub>5</sub> site =</b>	0.001	m <sup>3</sup> /s	=	0.5	l/s	=	3.4	l/s/ha
<b>Q<sub>10</sub> site =</b>	0.001	m <sup>3</sup> /s	=	0.7	l/s	=	4.3	l/s/ha
<b>Q<sub>25</sub> site =</b>	0.001	m <sup>3</sup> /s	=	0.9	l/s	=	5.7	l/s/ha
<b>Q<sub>30</sub> site =</b>	0.001	m <sup>3</sup> /s	=	0.9	l/s	=	6.0	l/s/ha
<b>Q<sub>50</sub> site =</b>	0.001	m <sup>3</sup> /s	=	1.1	l/s	=	7.0	l/s/ha
<b>Q<sub>100</sub> site =</b>	0.001	m <sup>3</sup> /s	=	1.3	l/s	=	8.5	l/s/ha
<b>Q<sub>500</sub> site =</b>	0.002	m <sup>3</sup> /s	=	1.9	l/s	=	12.0	l/s/ha

Note: For greenfield site, the critical duration is generally not relevant and the prediction of the peak rate of runoff using IoH124 does not require consideration of storm duration.

Soil WRA Class    Soil Type SPR Value

1	0.15
2	0.3
3	0.4
4	0.45
5	0.5

Region	Return Period								
	1	2	5	10	25	30	50	100	500
1	0.85	0.90	1.20	1.45	1.81	1.87	2.12	2.48	3.25
2	0.85	0.91	1.11	1.42	1.81	1.88	2.17	2.63	3.45
3	0.85	0.94	1.25	1.45	1.70	1.74	1.90	2.08	2.73
4	0.85	0.89	1.23	1.49	1.87	1.93	2.20	2.57	3.62
5	0.85	0.89	1.29	1.65	2.25	2.37	2.83	3.56	5.02
6	0.85	0.88	1.28	1.62	2.14	2.24	2.62	3.19	4.49
7	0.85	0.88	1.28	1.62	2.14	2.24	2.62	3.19	4.49
8	0.85	0.88	1.23	1.49	1.84	1.89	2.12	2.42	3.41
9	0.85	0.93	1.21	1.42	1.71	1.75	1.94	2.18	2.86
10	0.85	0.93	1.19	1.38	1.64	1.68	1.85	2.08	2.73

## **APPENDIX E**

**Design Settings**

Rainfall Methodology	FEH-13	Minimum Velocity (m/s)	1.00
Return Period (years)	2	Connection Type	Level Soffits
Additional Flow (%)	0	Minimum Backdrop Height (m)	0.200
CV	0.750	Preferred Cover Depth (m)	0.900
Time of Entry (mins)	5.00	Include Intermediate Ground	✓
Maximum Time of Concentration (mins)	30.00	Enforce best practice design rules	✓
Maximum Rainfall (mm/hr)	50.0		

**Nodes**

Name	Area (ha)	T of E (mins)	Cover Level (m)	Diameter (mm)	Easting (m)	Northing (m)	Depth (m)
Carpark 1	0.151	5.00	29.400		-40.843	90.182	0.700
7552			27.700	1500	-25.279	90.222	1.440
1			29.400	1200	-35.507	90.147	0.800
2			29.400	1200	-29.441	90.209	1.862

**Links**

Name	US Node	DS Node	Length (m)	ks (mm) / n	US IL (m)	DS IL (m)	Fall (m)	Slope (1:X)	Dia (mm)	T of C (mins)	Rain (mm/hr)
1.000	Carpark 1	1	1.000	0.600	28.700	28.600	0.100	10.0	150	5.01	50.0
1.002	2	7552	4.162	0.600	27.538	26.260	1.278	3.3	600	5.10	50.0
1.001	1	2	6.100	0.600	28.600	28.519	0.081	75.0	150	5.09	50.0

Name	Vel (m/s)	Cap (l/s)	Flow (l/s)	US Depth (m)	DS Depth (m)	Σ Area (ha)	Σ Add Inflow (l/s)	Pro Depth (mm)	Pro Velocity (m/s)
1.000	3.204	56.6	20.5	0.550	0.650	0.151	0.0	62	2.953
1.002	13.552	3831.8	20.5	1.262	0.840	0.151	0.0	31	3.727
1.001	1.162	20.5	20.5	0.650	0.731	0.151	0.0	123	1.320

**Pipeline Schedule**

Link	Length (m)	Slope (1:X)	Dia (mm)	Link Type	US CL (m)	US IL (m)	US Depth (m)	DS CL (m)	DS IL (m)	DS Depth (m)
1.000	1.000	10.0	150	Circular	29.400	28.700	0.550	29.400	28.600	0.650
1.002	4.162	3.3	600	Circular	29.400	27.538	1.262	27.700	26.260	0.840
1.001	6.100	75.0	150	Circular	29.400	28.600	0.650	29.400	28.519	0.731

Link	US Node	Dia (mm)	Node Type	MH Type	DS Node	Dia (mm)	Node Type	MH Type
1.000	Carpark 1		Junction		1	1200	Manhole	Adoptable
1.002	2	1200	Manhole	Adoptable	7552	1500	Manhole	Adoptable
1.001	1	1200	Manhole	Adoptable	2	1200	Manhole	Adoptable

**Simulation Settings**

Rainfall Methodology	FEH-13	Skip Steady State	x	2 year (l/s)	0.6
Summer CV	0.750	Drain Down Time (mins)	240	30 year (l/s)	1.2
Winter CV	0.840	Additional Storage (m <sup>3</sup> /ha)	20.0	100 year (l/s)	1.6
Analysis Speed	Normal	Check Discharge Rate(s)	✓	Check Discharge Volume	x

**Storm Durations**

15	60	180	360	600	960	2160	4320	7200	10080
30	120	240	480	720	1440	2880	5760	8640	

Return Period (years)	Climate Change (CC %)	Additional Area (A %)	Additional Flow (Q %)
2	0	0	0
30	35	0	0
100	45	0	0

**Pre-development Discharge Rate**

Site Makeup	Greenfield	Growth Factor 30 year	1.95
Greenfield Method	IH124	Growth Factor 100 year	2.48
Positively Drained Area (ha)	0.238	Betterment (%)	0
SAAR (mm)	569	QBar	0.6
Soil Index	3	Q 2 year (l/s)	0.6
SPR	0.40	Q 30 year (l/s)	1.2
Region	6	Q 100 year (l/s)	1.6
Growth Factor 2 year	0.88		

**Node 1 Online Hydro-Brake® Control**

Flap Valve	x	Objective	(HE) Minimise upstream storage
Downstream Link	1.001	Sump Available	✓
Replaces Downstream Link	✓	Product Number	CTL-SHE-0049-1000-0800-1000
Invert Level (m)	28.600	Min Outlet Diameter (m)	0.075
Design Depth (m)	0.800	Min Node Diameter (mm)	1200
Design Flow (l/s)	1.0		

**Node Carpark 1 Carpark Storage Structure**

Base Inf Coefficient (m/hr)	0.00000	Invert Level (m)	28.700	Slope (1:X)	1000.0
Side Inf Coefficient (m/hr)	0.00000	Time to half empty (mins)		Depth (m)	
Safety Factor	1.0	Width (m)	5.000	Inf Depth (m)	
Porosity	0.30	Length (m)	209.000		



**Results for 2 year Critical Storm Duration. Lowest mass balance: 99.91%**

Node Event	US Node	Peak (mins)	Level (m)	Depth (m)	Inflow (l/s)	Node Vol (m <sup>3</sup> )	Flood (m <sup>3</sup> )	Status
240 minute winter	Carpark 1	200	28.848	0.148	9.4	17.0011	0.0000	OK
30 minute winter	7552	27	26.267	0.007	0.9	0.0000	0.0000	OK
240 minute winter	1	200	28.848	0.248	8.5	0.2800	0.0000	SURCHARGED
30 minute winter	2	27	27.546	0.008	0.9	0.0090	0.0000	OK

Link Event (Upstream Depth)	US Node	Link	DS Node	Outflow (l/s)	Velocity (m/s)	Flow/Cap	Link Vol (m <sup>3</sup> )	Discharge Vol (m <sup>3</sup> )
240 minute winter	Carpark 1	1.000	1	8.5	0.640	0.150	0.0176	
240 minute winter	1	Hydro-Brake®	2	0.9				
30 minute winter	2	1.002	7552	0.9	1.516	0.000	0.0026	12.0

**Results for 30 year +35% CC Critical Storm Duration. Lowest mass balance: 99.91%**

Node Event	US Node	Peak (mins)	Level (m)	Depth (m)	Inflow (l/s)	Node Vol (m <sup>3</sup> )	Flood (m <sup>3</sup> )	Status
360 minute winter	Carpark 1	360	29.048	0.348	11.3	77.9789	0.0000	SURCHARGED
15 minute winter	7552	9	26.267	0.007	0.9	0.0000	0.0000	OK
360 minute winter	1	360	29.048	0.448	9.0	0.5071	0.0000	SURCHARGED
15 minute winter	2	9	27.546	0.008	0.9	0.0090	0.0000	OK

Link Event (Upstream Depth)	US Node	Link	DS Node	Outflow (l/s)	Velocity (m/s)	Flow/Cap	Link Vol (m <sup>3</sup> )	Discharge Vol (m <sup>3</sup> )
360 minute winter	Carpark 1	1.000	1	9.0	0.613	0.160	0.0176	
360 minute winter	1	Hydro-Brake®	2	0.9				
15 minute winter	2	1.002	7552	0.9	1.516	0.000	0.0026	13.9

**Results for 100 year +45% CC Critical Storm Duration. Lowest mass balance: 99.91%**

Node Event	US Node	Peak (mins)	Level (m)	Depth (m)	Inflow (l/s)	Node Vol (m <sup>3</sup> )	Flood (m <sup>3</sup> )	Status
600 minute winter	Carpark 1	585	29.185	0.485	10.6	121.2587	0.0000	FLOOD RISK
15 minute winter	7552	8	26.267	0.007	0.9	0.0000	0.0000	OK
600 minute winter	1	585	29.185	0.585	8.6	0.6611	0.0000	FLOOD RISK
15 minute winter	2	8	27.546	0.008	0.9	0.0090	0.0000	OK

Link Event (Upstream Depth)	US Node	Link	DS Node	Outflow (l/s)	Velocity (m/s)	Flow/Cap	Link Vol (m <sup>3</sup> )	Discharge Vol (m <sup>3</sup> )
600 minute winter	Carpark 1	1.000	1	8.6	0.685	0.152	0.0176	
600 minute winter	1	Hydro-Brake®	2	0.9				
15 minute winter	2	1.002	7552	0.9	1.516	0.000	0.0026	13.7

# APPENDIX F



## SuDS Water quantity and Quality – LLFA Technical Assessment Proforma

### Introduction

*This proforma identifies the information required by Essex LLFA to enable technical assessment the Designers approach to water quantity and water quality as part of SuDS design approach in compliance with Essex SuDS Design Guide.*

*Completion of the proforma will also allow for technical assessment against Non-statutory technical standards (NSTS) for Sustainable Drainage. The proforma will accompany the site specific Flood Risk Assessment and Drainage Strategy submitted as part of the planning application.*

**Please complete this form in full for full applications and the coloured sections for outline applications. This will help us identify what information has been included and will assist with a smoother and quicker application.**

### Instructions for use

Use the units defined for input of figures

Numbers in brackets refer to accompanying notes.

Where .....m<sup>3</sup> .....m<sup>3</sup>/m<sup>2</sup> are noted – both values should be filled in.

### Site details

1.1 Planning application reference (if known)

1.2 Site name

1.3 Total application site area <sup>(1)</sup> ha

1.4 Predevelopment use <sup>(4)</sup>

1.5 Post development use

If other, please sepcify

1.6 Urban creep applicable if yes, factor applied:

1.7 Proposed design life / planning application life

1.8 Method(s) of discharge: <sup>(5)</sup>

*Reuse*

*Infiltration*

*Hybrid*

*Waterbody*

*Storm sewer*

*Combined sewer*

1.9 Is discharge direct to estuary / sea

1.10 Have agreements in principle (where applicable) for discharge been provided



## SuDS Water quantity and Quality – LLFA Technical Assessment

### Calculation inputs

2.1	Area within site which is drained by SuDS <sup>(2)</sup>	m <sup>2</sup>
2.2	Impermeable area drained pre development <sup>(3)</sup>	m <sup>2</sup>
2.3	Impermeable area drained post development <sup>(3)</sup>	m <sup>2</sup>
2.4	Additional impermeable area (2.3 minus 2.2)	m <sup>2</sup>
2.5	Method for assessing greenfield runoff rate	
2.6	Method for assessing brownfield runoff rate	
2.7	Coefficient of runoff (Cv) <sup>(6)</sup>	
2.8	Source of rainfall data (FEH Preferred)	
2.9	Climate change factor applied	%

### Attenuation (positive outlet)

2.10 Drainage outlet at risk of drowning (tidal locking, elevated water levels in watercourse/sewer)  
 Note: Vortex controls require conditions of free discharge to operate as per manufacturers specification.

2.11	Invert level at final outlet	mAOD
2.12	Design level used for surcharge water level at point of discharge <sup>(16)</sup>	mAOD

### Infiltration (Discharge to Ground)

2.13	Have infiltration tests been undertaken	
2.14	If yes, which method has been used	
2.15	Infiltration rate (where applicable)	m/s
2.16	Depth to highest known ground water table	mAOD
2.17	If there are multiple infiltration features please specify where they can be found in the FRA	
2.18	Depth of infiltration feature	mAOD
2.19	Factor of safety used for sizing infiltration storage	



## SuDS Water quantity and Quality – LLFA Technical Assessment Proforma

### Calculation outputs

Sections 3 and 4 refer to site where storage is provided by full attenuation or partial infiltration. Where all flows are infiltrated to ground go straight to Section 6.

#### 3.0 Greenfield runoff rates (incl. Urban Creep)

3.1 1 in 1 year rainfall l/s/ha, l/s for the site

3.2 1 in 30 year rainfall l/s/ha, l/s for the site

3.3 1 in 100 year rainfall + CCA l/s/ha, l/s for the site

#### 4.0 Brownfield runoff rates (incl. Urban Creep)

4.1 1 in 1 year rainfall l/s/ha, l/s for the site

4.2 1 in 30 year rainfall l/s/ha, l/s for the site

4.3 1 in 100 year rainfall + CCA l/s/ha, l/s for the site

#### 5.0 Proposed maximum rate of runoff from site (incl. Urban Creep) <sup>(7)</sup>

5.1 1 in 1 year rainfall l/s/ha, l/s for the site

5.2 1 in 30 year rainfall l/s/ha, l/s for the site

5.3 1 in 100 year rainfall + CCA l/s/ha, l/s for the site

#### 6.0 Attenuation storage to manage flow rates from site (incl. **Climate Change Allowance (CCA)** and Urban Creep)

6.1 Storage - 1 in 100 year + CCA <sup>(9)</sup> m<sup>3</sup> m<sup>3</sup>/m<sup>2</sup>

6.2 50% storage drain down time 1 in 30 years hours

#### 7.0 Controlling volume of runoff from the site<sup>(10)</sup>

7.1 Pre development runoff volume<sup>(12)</sup> (development area) m<sup>3</sup> for the site

7.2 Post development runoff volume (unmitigated) <sup>(12)</sup> m<sup>3</sup> for the site

7.3 Volume to be controlled (5.2 - 5.1) m<sup>3</sup> for the site



## Essex County Council

7.4 Volume control provided by:

- Interception losses<sup>(13)</sup> m<sup>3</sup>
- Rain harvesting <sup>(14)</sup> m<sup>3</sup>
- Infiltration m<sup>3</sup>
- Attenuation m<sup>3</sup>
- Separate volume designated as long term storage<sup>(15)</sup> m<sup>3</sup>

7.5 Total volume control (sum of inputs for 5.4) m<sup>3</sup> <sub>(17)</sub>

### 8.0 Site storage volumes (full infiltration only)

- 8.1 Storage - 1 in 30 year + CCA <sup>(8)</sup> m<sup>3</sup> m<sup>3</sup>/m<sup>2</sup> (of developed impermeable area)
- 8.2 Storage - 1 in 100 year + CCA <sup>(11)</sup> m<sup>3</sup> m<sup>3</sup>/m<sup>2</sup>

## SuDS Water quantity and Quality – LLFA Technical Assessment Proforma

### Design Inputs

Proposed site use

Pollution hazard category (see C753 Table 26.2)

High risk area defined as area storing fuels chemicals, refuelling area, washdown area, loading bay.

### Design Outputs

List order of SuDS techniques proposed for treatment

Note that gully pots, pipes and tanks are not accepted by Essex LLFA as a form of treatment (for justification see C753 Section 4.1, Table 26.15 and Box B.2)

Are very high pollution risk areas drained separate from SuDS to foul system

### Other

Please include any other information that is relevant to your application





## SuDS Water quantity and Quality – LLFA Technical Assessment Proforma

### Notes

1. All area with the proposed application site boundary to be included.
2. The site area which is positively drained includes all green areas which drain to the SuDS system and area of surface SuDS features. It excludes large open green spaces which do not drain to the SuDS system.
3. Impermeable area should be measured pre and post development. Impermeable surfaces include, roofs, pavements, driveways and paths where runoff is conveyed to the drainage system.
4. Predevelopment use may impact on the allowable discharge rate. The LLFA will seek for reduction in flow rates to GF (Essex SuDS Design Guide).
5. Runoff may be discharge via one or more methods.
6. Sewers for Adoption 6<sup>th</sup> Edition recommends a Cv of 100% when designing drainage for impermeable area (assumes no loss of runoff from impermeable surfaces) and 0% for permeable areas. Where lower Cv's are used the applicant should justify the selection of Cv.
7. It is Essex County Council's preference that discharge rates for all events up to the 1 in 100 year event plus climate change are limited to the 1 in 1 greenfield rate. This is also considered to mitigate the increased runoff volumes that occur with the introduction of impermeable surfaces. If discharge rates are limited to a range of matched greenfield flows then it is necessary to provide additional mitigation of increased runoff volumes by the provision of Long-term Storage.
8. Storage for the 1 in 30 year must be fully contained within the SuDS components. Note that standing water within SuDS components such as ponds, basins and swales is not classified as flooding. Storage should be calculated for the critical duration rainfall event.
9. Runoff generated from rainfall events up to the 1 in 100 year will not be allowed to leave the site in an uncontrolled way. Temporary flooding of designated areas to shallow depths and velocities may be acceptable.
10. The following information should only be provided if increased runoff volumes are not mitigated by limiting all discharge rates back to the greenfield 1 in 1 year rate.
11. Climate change is specified as 40% increase to rainfall intensity, unless otherwise agreed with the LLFA / EA.
12. To be determined using the 100 year return period 6 hour duration winter rainfall event.
13. Where Source Control is provided Interception losses will occur. An allowance of 5mm rainfall depth can be subtracted from the net inflow to the storage calculation where interception losses are demonstrated. The Applicant should demonstrate use of subcatchments and source control techniques. Further information is available in the SuDS Design Guide.
14. Please refer to Rain harvesting BS for guidance on available storage.
15. Flows within long term storage areas should be infiltrated to the ground or discharged at low flow rate of maximum 2 l/s/ha.
16. Careful consideration should be used for calculations where flow control / storage is likely to be influenced by surcharged sewer or peak levels within a watercourse. Outlets can be tidally locked where discharge is direct to estuary or sea. Calculations should demonstrate that risk of downed outlet has been taken into consideration. Vortex controls require conditions of free discharge to operate as per specification.
17. In controlling the volume of runoff the total volume from mitigation measures should be greater than or equal to the additional volume generated.

# PLANS

A3 SHEET @ 1:500

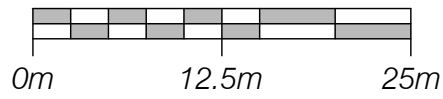

This drawing is copyright © and must not be reproduced in whole or part without obtaining written authority from John Finch Partnership. Do not scale from this drawing. All dimensions to be checked on site. Refer any discrepancies to the project Architect.



**Accommodation Schedule**

Plot No.	Accommodation	Area (m <sup>2</sup> )	Amenity (m <sup>2</sup> )
01	4 Bedroom 7 person house	110	108
02	4 Bedroom 7 person house	110	104
03	4 Bedroom 7 person house	110	104
04	4 Bedroom 7 person house	110	104
05	4 Bedroom 7 person house	110	110
06	1 Bedroom 2 person apartment	60	4
G1/2	Private Double Garage	42	

**Key:**

- Retained Tree
- Proposed Tree
- Permeable gravel driveway
- Concrete pavers
- Cycle Stores
- Bins
- 1800mm h. close boarded timber fence
- 1800mm h. 225mm thick external brick wall

revision

issue

PLANNING

client

Chelmsford City Council

project

Medway Close, Chelmsford

title

Proposed Block Plan

**john finch partnership**  
 chartered architects & town planning consultants



88 Broomfield Road  
 Chelmsford CM1 1SS  
 01245 354319/250780  
 admin@johnfinchpartnership.co.uk

www.johnfinchpartnership.co.uk

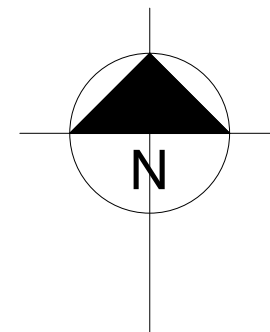

Site Area= 0.23ha

date	08.11.22	scale	1:500 @ A3
drawn	jm/jh	checked	jm
dwg no	3556:02	revision	D

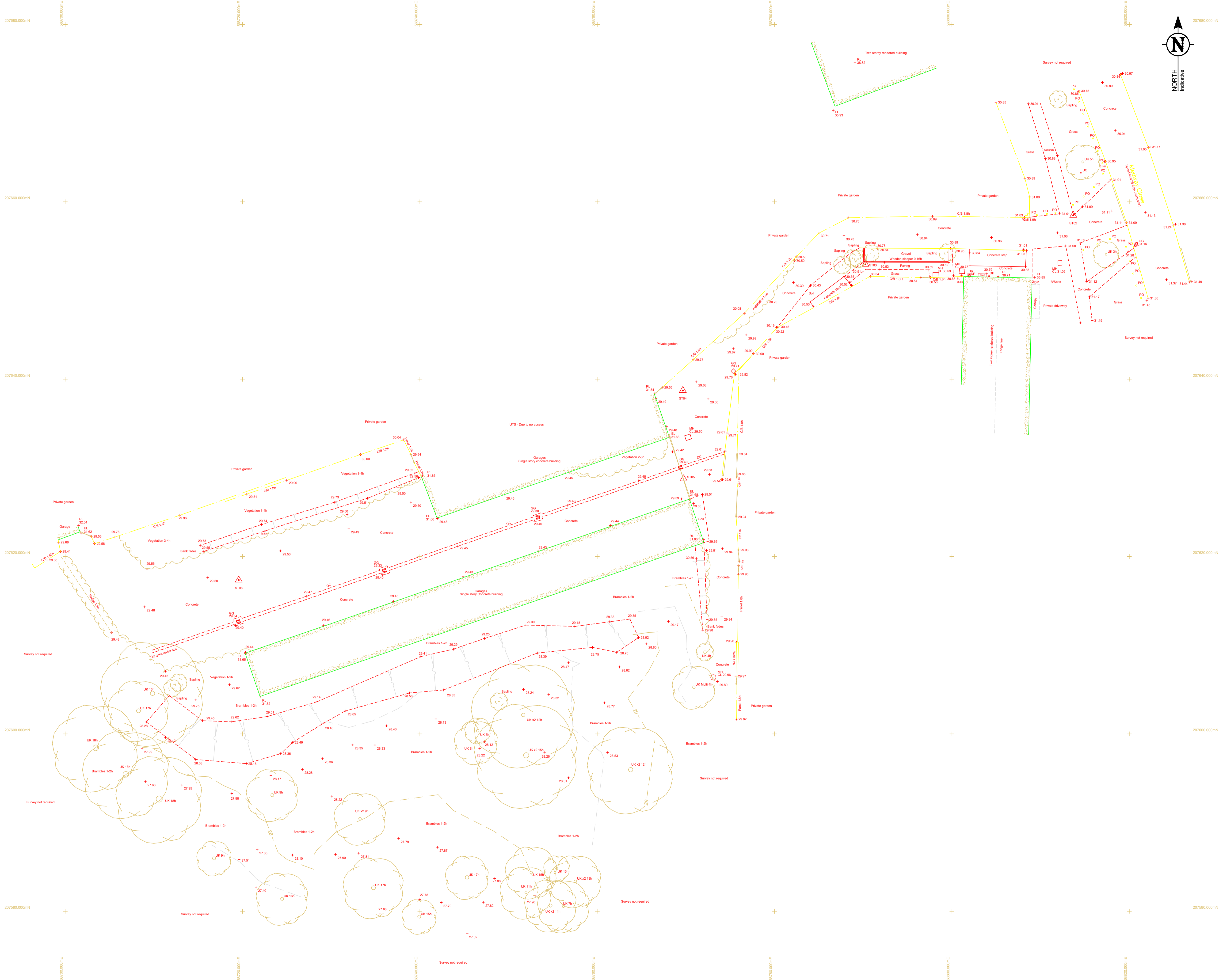

**TOPOGRAPHICAL & MEASURED BUILDING SURVEYS**

**ABBREVIATIONS & SYMBOLS**

AH	Arch Head Height	ER	Earth Road	RSD	Roller Shutter Door
AB	Air Brick	ET	ETP Transformer	RSJ	Reinforced Steel Joist
AR	Assumed Route	FB	Flower Bed	SI	Sign Post
AV	Air Valve	FBD	Floor Board Direction	SP	Arch Spring Point Height
BB	Balisha Beacon	FH	Fire Hydrant	SV	Stop Valve
BH	Born Hole	FL	Floor Level	SY	Cable Stay
BL	Bed Level	FP	Flag Pole	SW	Surface Water
BO	Boisard	FW	Foot Water	Tac	Tactile Paving
BPF	Brace Post	GC	Gully Grate	TC	Telecom Cover
BS	Bus Stop	GV	Gas Valve	TH	Trail Pit
BU	Bush	HH	Head Height	THL	Threshold Level
BW	Barbed Wire Fence	IG	Inspection Cover	ToW	Top of Wall
BX	Box (Utilities)	IL	Invert Level	TL	Traffic Light
CB	Close Board Fence	IR	Iron Railings	TP	Telegraph Pole
CH	Chimney	KD	Kern Disset	TS	Traffic Signal Cover
CL	Cover Level	LP	Lamp Post	TV	Cable TV Cover
CL	Chain Link Fence	MH	Manhole	UB	Universal Beam
CLev	Ceiling Level	MP	Marker Post	UC	Unknown Cover
Col	Column	NB	Name Board	UK	Unknown Tree
C/P	Chestnut Paling Fence	OHL	Overhead Line (approx)	UMG	Unmade Ground
CR	Cable Riser	Pa	Panel Fence	USB	Under Side Beam
CW	Chicken Wire	PS	Post Box	UTL	Unable To Lift
DC	Drainage Channel	PM	Parking Meter	UTS	Unable To Survey
DH	Door Head Height	PO	Post	VP	Vent Pipe
DI	Disinfectant	PR	Post & Rail Fence	WB	Waste Bin
DP	Down Pipe	PW	Post & Wire Fence	WH	Wedge Hole
DR	Drain	P/W	Partion Wall	WL	Water Level
EB	Electric Box	RE	Roofing Eye	WM	Water Meter
EC	Electric Supply Cover	RL	Ridge Level	WO	Wash Out
EL	Eaves Level	RP	Reflector Post	WC	Floor to Ceiling Height
EP	Electric Pole	RS	Road Sign	W/C	Floor to False Ceiling Ht
				SC	Survey Control Station

**DRAWING NOTES**

**Topographical Surveys**

Trees are drawn to scale showing the average canopy spread. Descriptions and heights should be used as a guide only.

All building names, descriptions, number of storeys, construction type including roof line details are indicative only and taken externally from ground level.

All below ground details including drainage, voids and services have been identified from above ground and therefore all details relating to these features including sizes, depth, description etc will be approximate only. All critical dimensions and connections should be checked and verified prior to starting work.

Detail, services and features may not have been surveyed if obstructed or not reasonably visible at the time of the survey.

Surveyed physical features may not necessarily represent the legal boundary line.

**Measured Building Surveys**

Measurements to internal walls are taken to the wall finishes at approx 1m above the floor level and the wall assumed to be vertical.

Cill heights are measured as floor to the cill and head heights are measured from cill to the top of window.

**General**

The contractor must check and verify all site and building dimensions, levels, utilities and drainage details and connections prior to commencing work. Any errors or discrepancies must be notified to Survey Solutions immediately.

The accuracy of the digital data is the same as the plotting scale implies. All dimensions are in metres unless otherwise stated.

The survey control listed is only to be used for topographical surveys at the stated scale. All control must be checked and verified prior to use.

© Land Survey Solutions Limited holds the copyright to all the information contained within this document and their written consent must be obtained before copying or using the data other than for the purpose it was originally supplied.

Do not scale from this drawing.

**SURVEY CONTROL CO-ORDINATES**

STATIONS	EASTINGS	NORTHINGS	LEVEL	DESCRIPTION
ST01	568803.087	207696.286	30.750	PK Nail
ST02	568813.677	207658.483	31.076	PK Nail
ST03	568790.241	207652.858	30.560	PK Nail
ST04	568769.655	207638.723	29.622	PK Nail
ST05	568769.738	207628.759	29.453	PK Nail
ST06	568719.574	207617.349	29.503	PK Nail

**SURVEY GRID AND LEVEL DATUM**

The coordinate system established for this survey is related to Ordnance Survey (OS) national grid at a single point using Smartnet, then orientated to grid north with a scale factor of 1.000.

The level datum established for this survey is related to Ordnance Survey (OS) using GPS Smartnet.

To avoid discrepancies any coordinated data used in conjunction with this survey must be derived directly from this control data.

REV	DESCRIPTION	DRAWN	APPR	DATE

**SURVEY SOLUTIONS**

LAND SURVEYING  
BUILDING SURVEYING  
UNDERGROUND SURVEYING  
SITE ENGINEERING  
MONITORING

0845 040 5969  
survey-solutions.co.uk

PORCH BEFORD COVENTRY GLASGOW LONDON MANCHESTER NORWICH NOTTINGHAM YEOUL

PROJECT TITLE  
**MEDWAY CLOSE, CHELMSFORD, ESSEX, CM1 2LH**

DRAWING DETAIL  
**TOPOGRAPHICAL SURVEY**  
Sheet 1 of 1

CLIENT <b>CHELMSFORD CITY COUNCIL</b>	SCALE <b>1:200</b>
SURVEYOR <b>GB</b>	DWG STATUS <b>FINAL</b>
SURVEY DATE <b>27/04/22</b>	CHECKED BY <b>JG</b>
APPROVED BY <b>SB</b>	REVISION <b>ISSUE DATE</b>
DRAWING NUMBER <b>41368BWS-01</b>	<b>28/04/22</b>



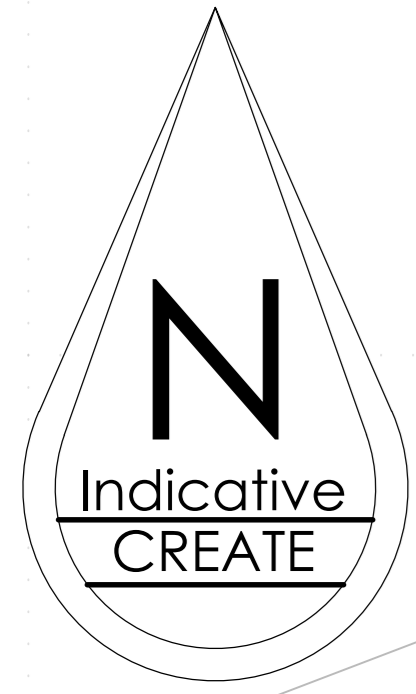

207670  
207660  
207650  
207640  
207630  
207620  
207610  
207600  
207590  
207580  
207570

568650  
568670  
568690  
568710  
568730  
568750  
568770  
568790  
568810

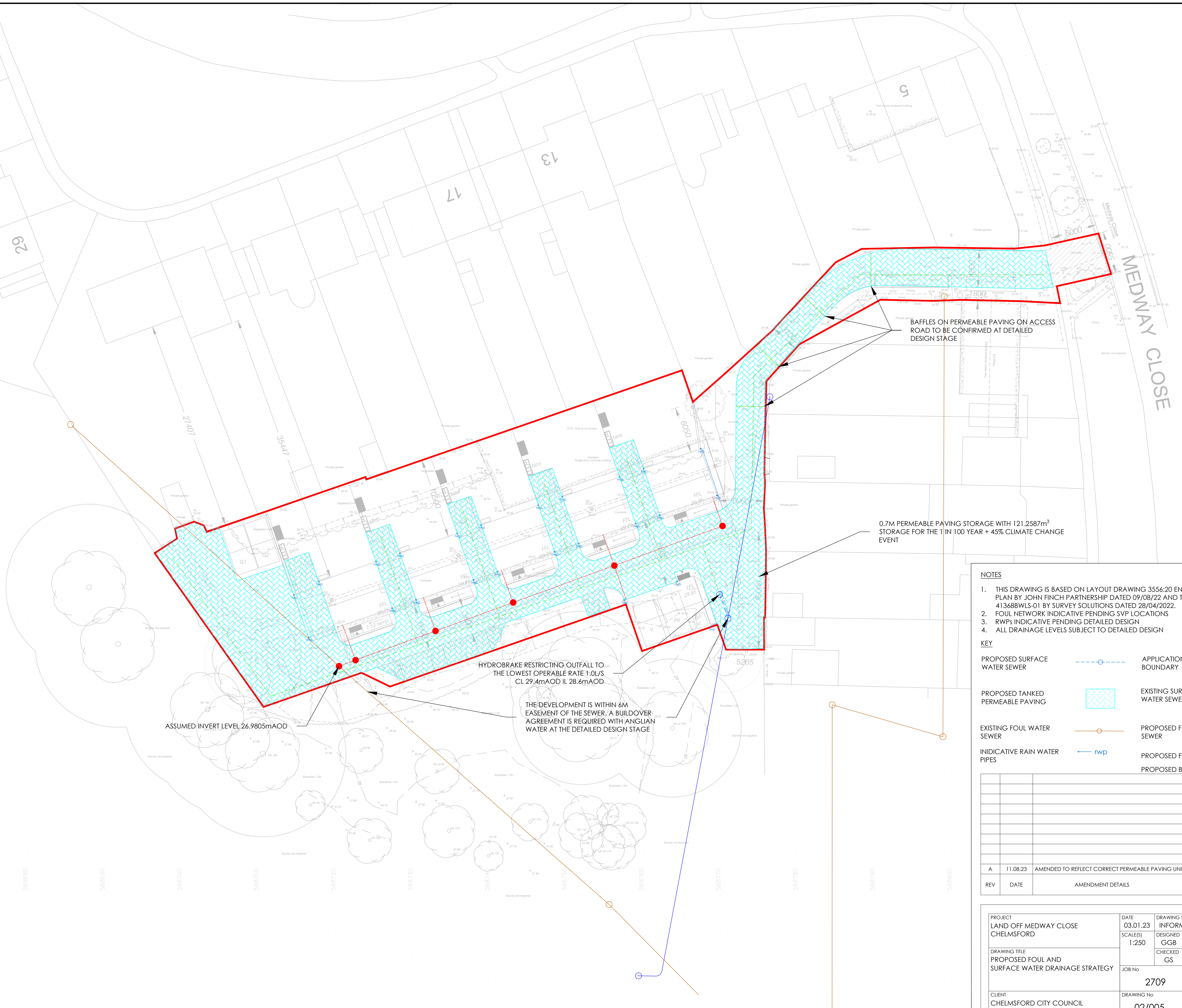

**NOTES**

1. THIS DRAWING IS BASED ON LAYOUT DRAWING 3556:20 ENTITLED PROPOSED BLOCK PLAN BY JOHN FINCH PARTNERSHIP DATED 09/08/22 AND TOPOGRAPHIC SURVEY 41368BYLS-01 BY SURVEY SOLUTIONS DATED 28/04/2022.
2. FOUL NETWORK INDICATIVE PENDING SVR LOCATIONS
3. RWP'S INDICATIVE PENDING DETAILED DESIGN
4. ALL DRAINAGE LEVELS SUBJECT TO DETAILED DESIGN

**KEY**

PROPOSED SURFACE WATER SEWER		APPLICATION SITE REDLINE BOUNDARY	
PROPOSED TANKED PERMEABLE PAVING		EXISTING SURFACE WATER SEWER	
EXISTING FOUL WATER SEWER		PROPOSED FOUL WATER SEWER	
INDICATIVE RAIN WATER PIPES		PROPOSED FIN DRAINS	
		PROPOSED BAFFLES	

REV	DATE	AMENDMENT DETAILS	DRAWN	APPROVED
A	11.08.23	AMENDED TO REFLECT CORRECT PERMEABLE PAVING UNITS	GGB	GS

PROJECT LAND OFF MEDWAY CLOSE CHELMSFORD	DATE 03.01.23	DRAWING STATUS INFORMATION	
DRAWING TITLE PROPOSED FOUL AND SURFACE WATER DRAINAGE STRATEGY	SCALE(S) 1:250	DESIGNED GGB	
CLIENT CHELMSFORD CITY COUNCIL	JOB No 2709	CHECKED GS	APPROVED GS
	DRAWING No 02/005	REVISION A	

Create Consulting Engineers accept no responsibility for any unauthorised amendments to this drawing. Only figured dimensions are to be worked to. COPYRIGHT © RESERVED

www.createconsultingengineers.co.uk

DO NOT SCALE ORIGINAL SHEET SIZE - A1 Landscape

MINIMUM DIMENSIONS FOR ACCESS FITTINGS AND INSPECTION CHAMBERS					
TYPE OF ACCESS	DEPTH TO INVERT FROM COVER LEVEL (m)	MINIMUM INTERNAL DIMENSIONS		MINIMUM CLEAR OPENING SIZE	
		LENGTH x WIDTH (mm x mm)	CIRCULAR (mm)	LENGTH x WIDTH (mm x mm)	CIRCULAR (mm)
RODDING EYE		AS DRAIN BUT 100mm MINIMUM			SAME SIZE AS FITTING
ACCESS FITTING					SAME SIZE AS ACCESS FITTING
SMALL 150mm Ø	0.6m OR LESS EXCEPT WHERE SPECIFIED AS A CHAMBER	150 x 100	150	150 x 100	
SMALL 150mm x 100mm		225 x 100	225	225 x 100	
INSPECTION CHAMBER					
SHALLOW	0.6m OR LESS	225 x 100	190	190	
MEDIUM	1.2m OR LESS	450 x 450	450	MINIMUM 450 x 450	450
DEEP	GREATER THAN 1.2m	450 x 450	450	MAXIMUM 300 x 300	ACCESS RESTRICTED TO 300 MAXIMUM

MINIMUM DIMENSIONS FOR MANHOLES					
TYPE OF ACCESS	SIZE OF LARGEST PIPE (DN)	MINIMUM INTERNAL DIMENSIONS		MINIMUM CLEAR OPENING SIZE	
		RECTANGULAR LENGTH x WIDTH (mm x mm)	CIRCULAR DIAMETER (mm)	RECTANGULAR LENGTH x WIDTH (mm x mm)	CIRCULAR DIAMETER (mm)
MANHOLE LESS THAN 1.5m DEEP TO SOFT	LESS THAN OR EQUAL TO 150	750 x 475	1000	750 x 475	N/A
	225	1200 x 475	1200	1200 x 475	
	300	1200 x 750	1200		
MANHOLE GREATER THAN 1.5m DEEP TO SOFT	GREATER THAN 300	1800 x 475	THE LARGER OF 1800 OR (DN+400)		600
	450	1200 x 1000	1200		
	600	1200 x 1075	1200		
MANHOLE GREATER THAN 1.5m DEEP TO HARD	GREATER THAN 450	1800 x 775	THE LARGER OF 1800 OR (DN+775)		600
	600	1000 x 800	1000		
	750	1200 x 800	1200		
MANHOLE SHAFT GREATER THAN 1.5m DEEP TO SOFT	STEPS				600
	LADDER				600
	WRENCH	900 x 600	900	600 x 600	600

NOTES:  
 1. LARGER SIZES MAY BE REQUIRED FOR MANHOLES ON BENDS OR WHERE THERE ARE JUNCTIONS.  
 2. MAY BE REDUCED TO 80mm WHERE REQUIRED BY HIGHWAY LOADING CONSIDERATIONS, SUBJECT TO A SAFE SYSTEM OF WORK BEING SPECIFIED.  
 3. NOT APPLICABLE DUE TO WORKING SPACE NEEDED.  
 4. MINIMUM HEIGHT OF CHAMBER IS 150mm FROM FINISHING TO INVERT OR REDUCING SLAB.  
 5. MINIMUM CLEAR SPACE BETWEEN LADDER OR STEPS AND THE OPPOSITE FACE OF THE SHAFT SHOULD BE APPROXIMATELY 300mm.  
 6. WRENCH ONLY - NO STEPS OR LADDERS PERMITTED ON CHAMBER.  
 7. THE MINIMUM SIZE OF ANY MANHOLE SERVING A SEWER IS (i.e. ANY DRAIN SERVING MORE THAN ONE PROPERTY SHOULD BE 1200mm x 750mm RECTANGULAR OR 1200mm DIAMETER.

COVER GRADE TO BS EN 124	LOCATION
D400	FOR USE IN INDUSTRIAL ROADS AND PARKING AREAS ACCESSIBLE TO ALL TYPES OF ROAD VEHICLES INCLUDING HGVs
C250*	FOR USE IN PRIVATE ROADS OR PARKING AREAS, e.g. CAR PARKS AND VENDOR PRIVATE ROADS ACCESSIBLE TO REFUSE VEHICLES, FIRE APPLIANCES, etc. WITH POSSIBLE OCCASIONAL HGV USE
B125	FOR USE IN FOOTWAYS, PEDESTRIAN AREAS, DRIVEWAYS AND CAR PARKS ACCESSIBLE BY LIGHT VEHICLES ONLY
A15	FOR USE IN AREAS WHICH CAN BE USED ONLY BY PEDESTRIANS AND PEDAL CYCLISTS

\* D400 MAY BE USED IN LIEU OF C250 IF PREFERRED

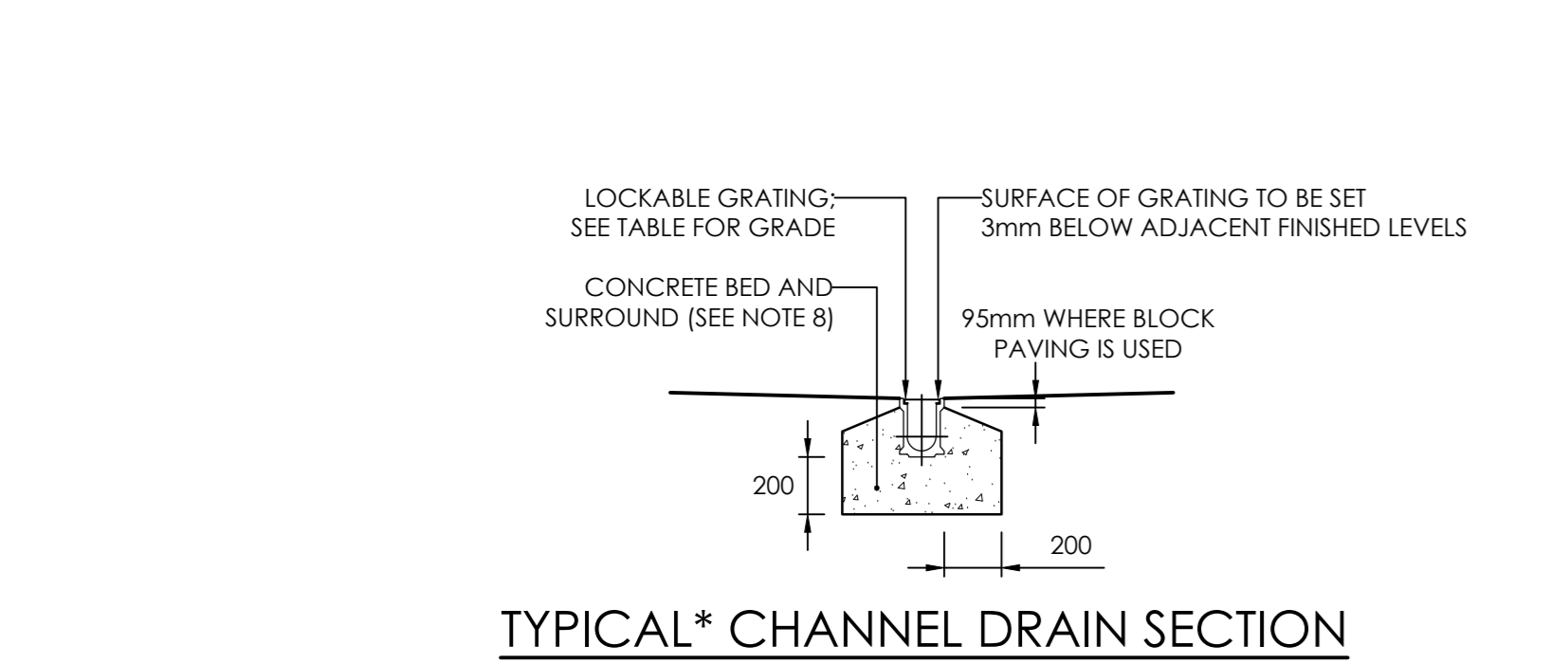
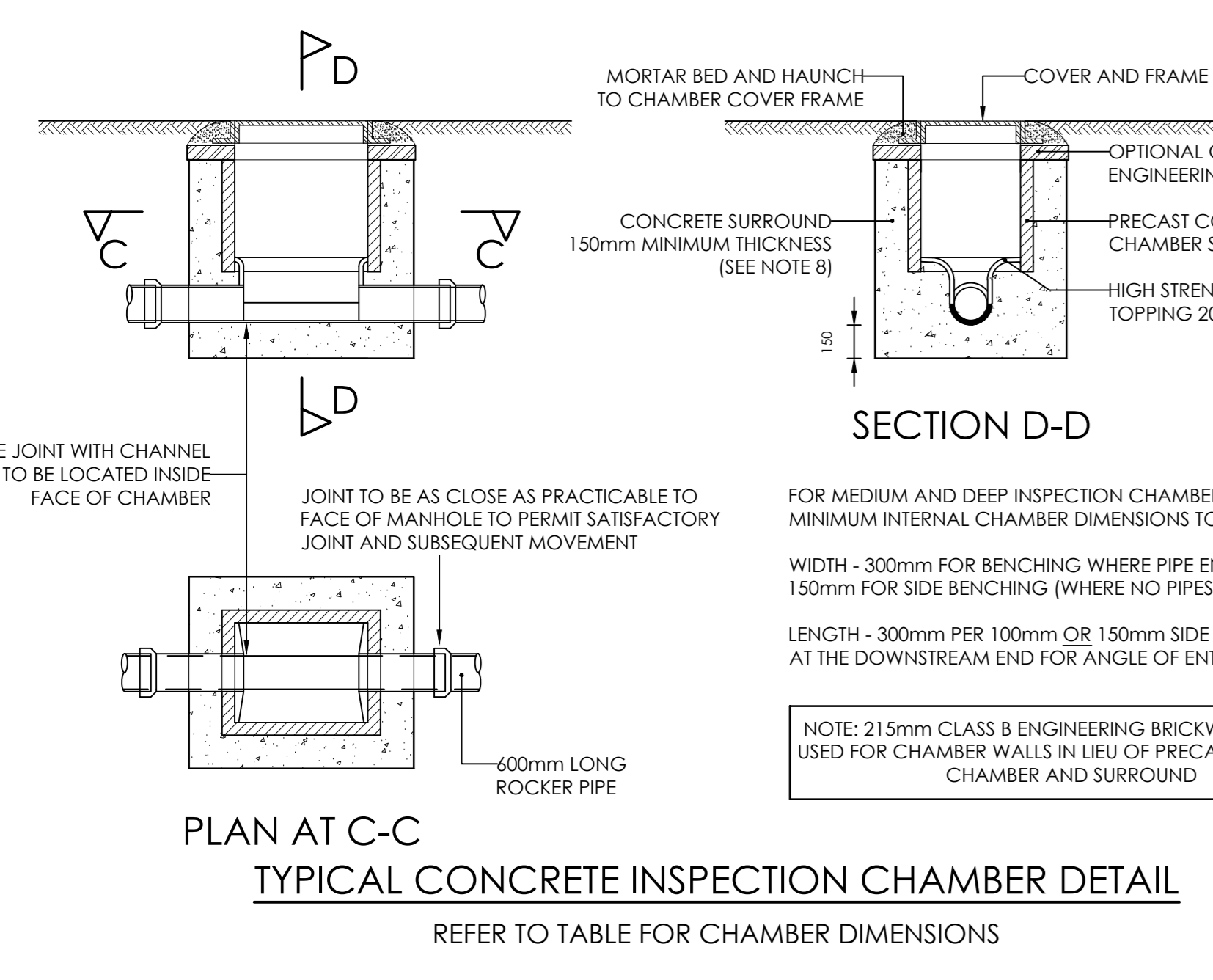

ROAD GRADIENT	SUB-BASE THICKNESS (mm)	BAFFLE SPACING (m)
1:40 OR FLATTER	700	-
1:30 - 1:39	700	21
1:20 - 1:29	700	14

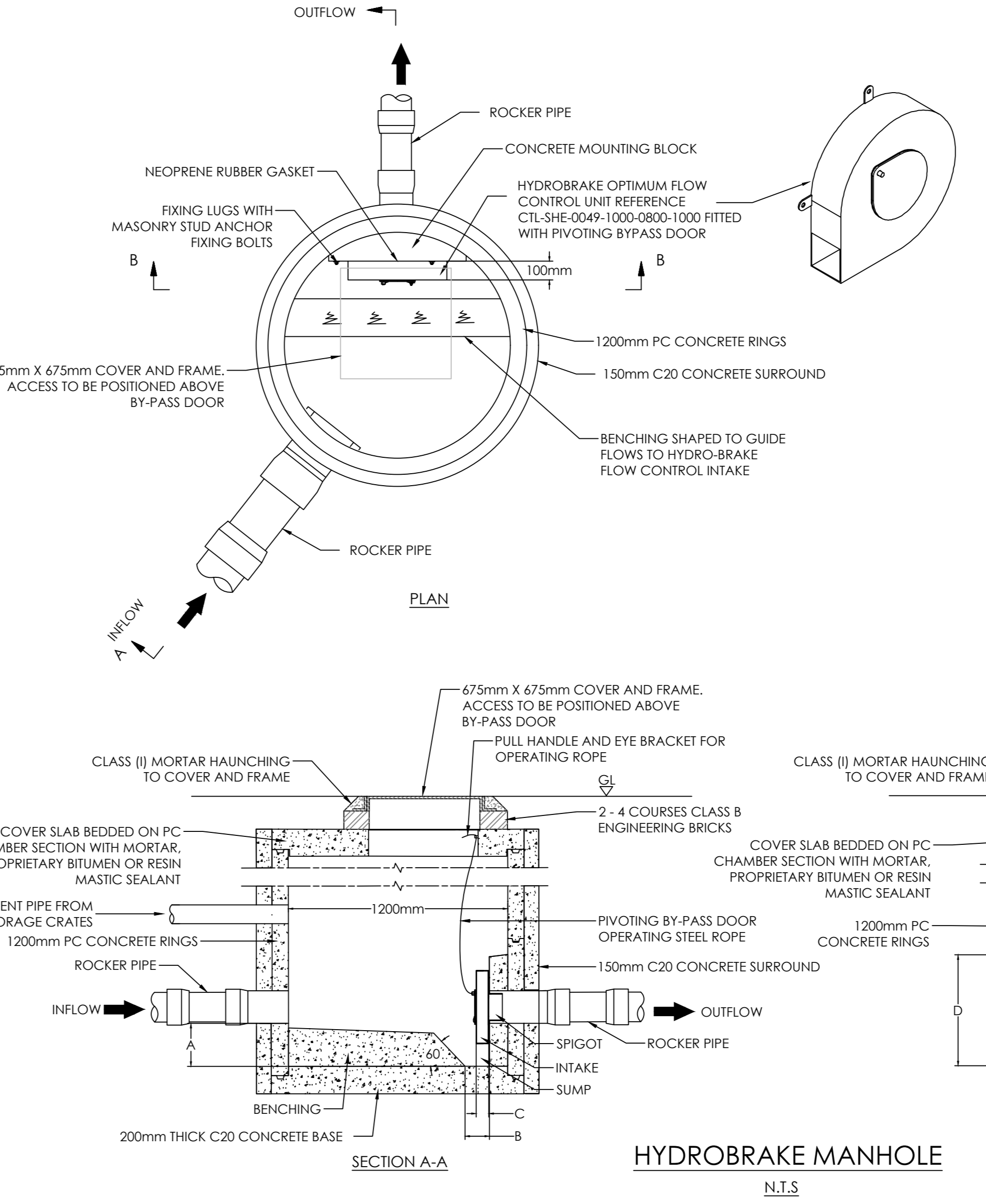
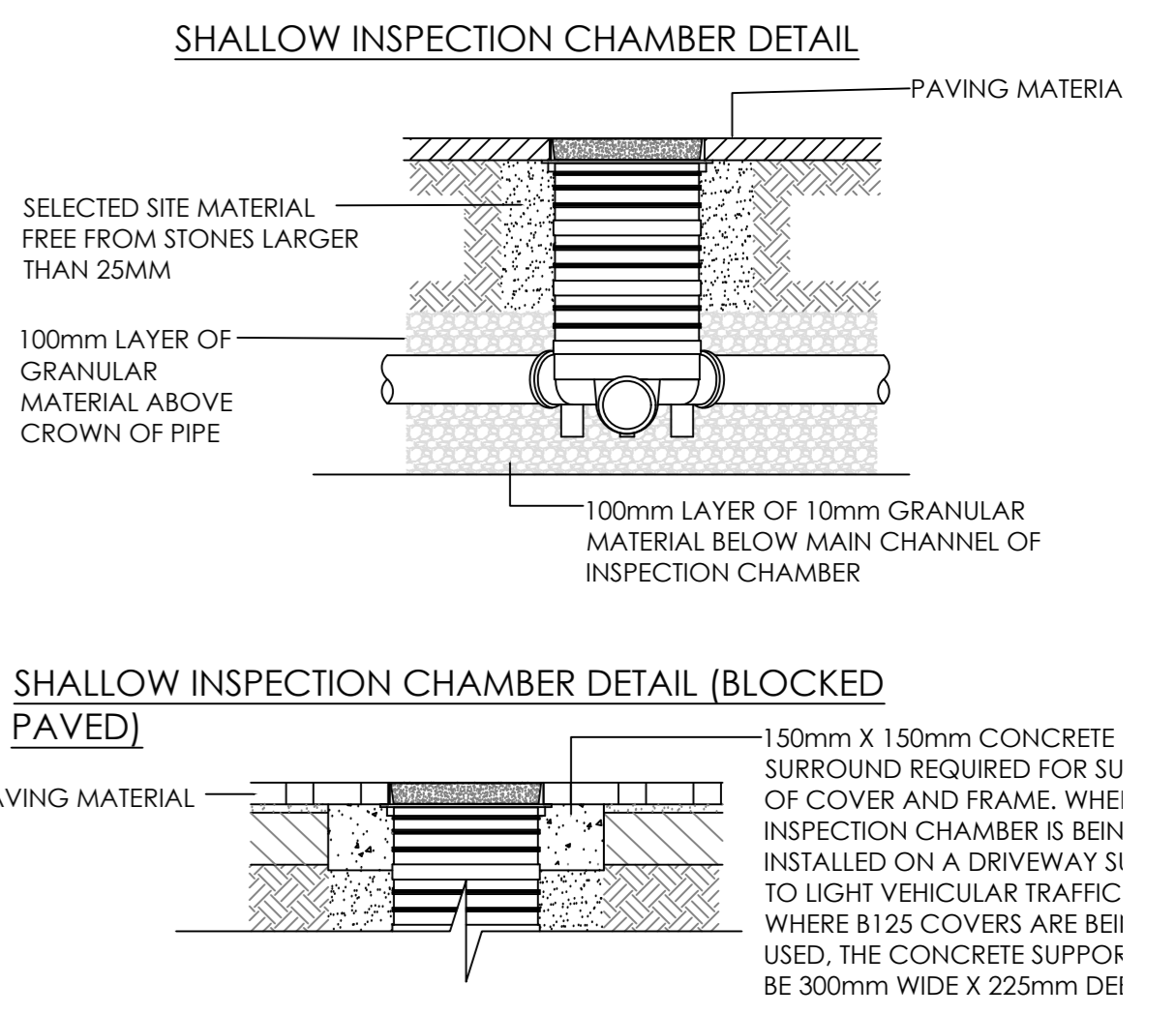
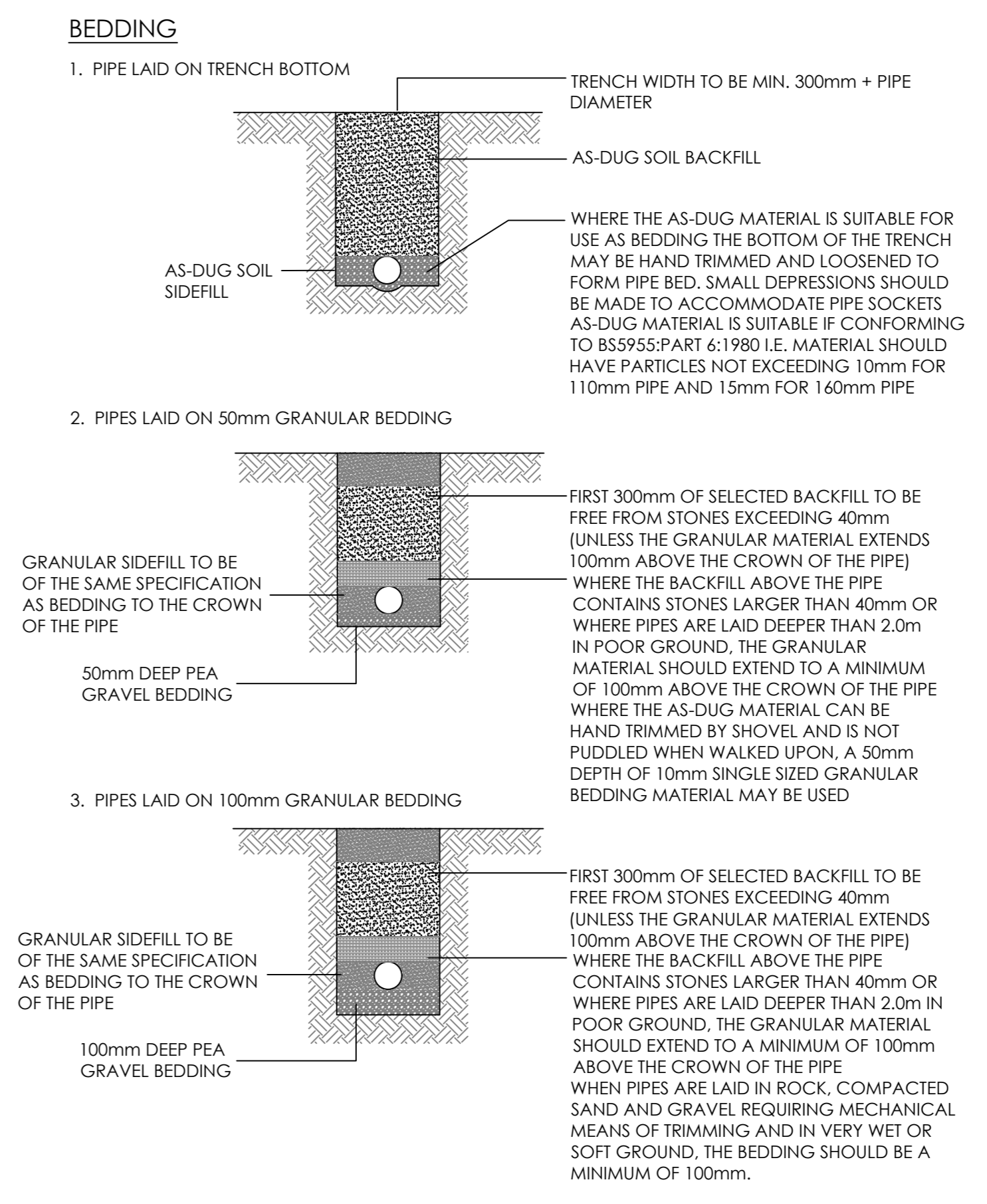
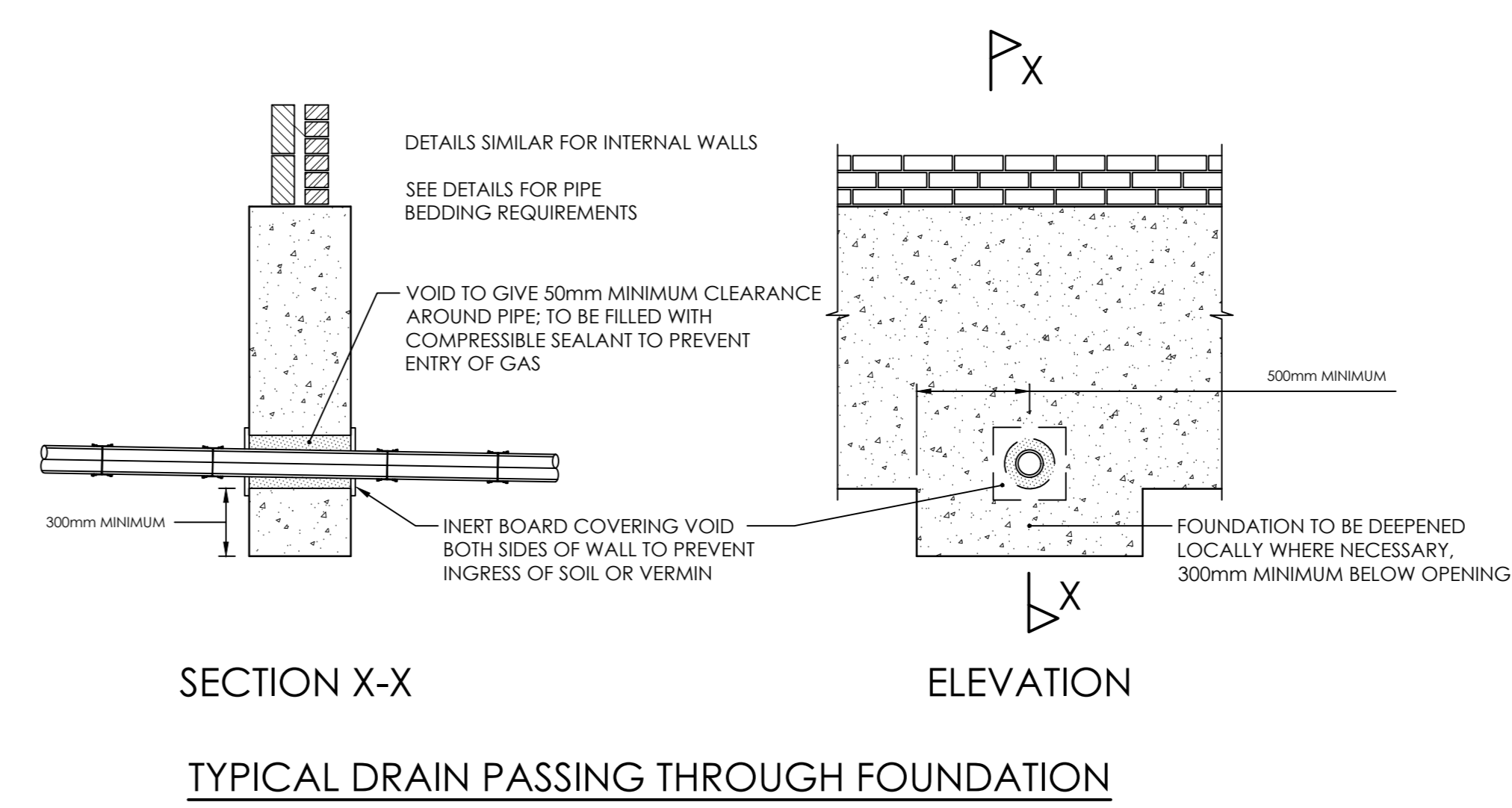
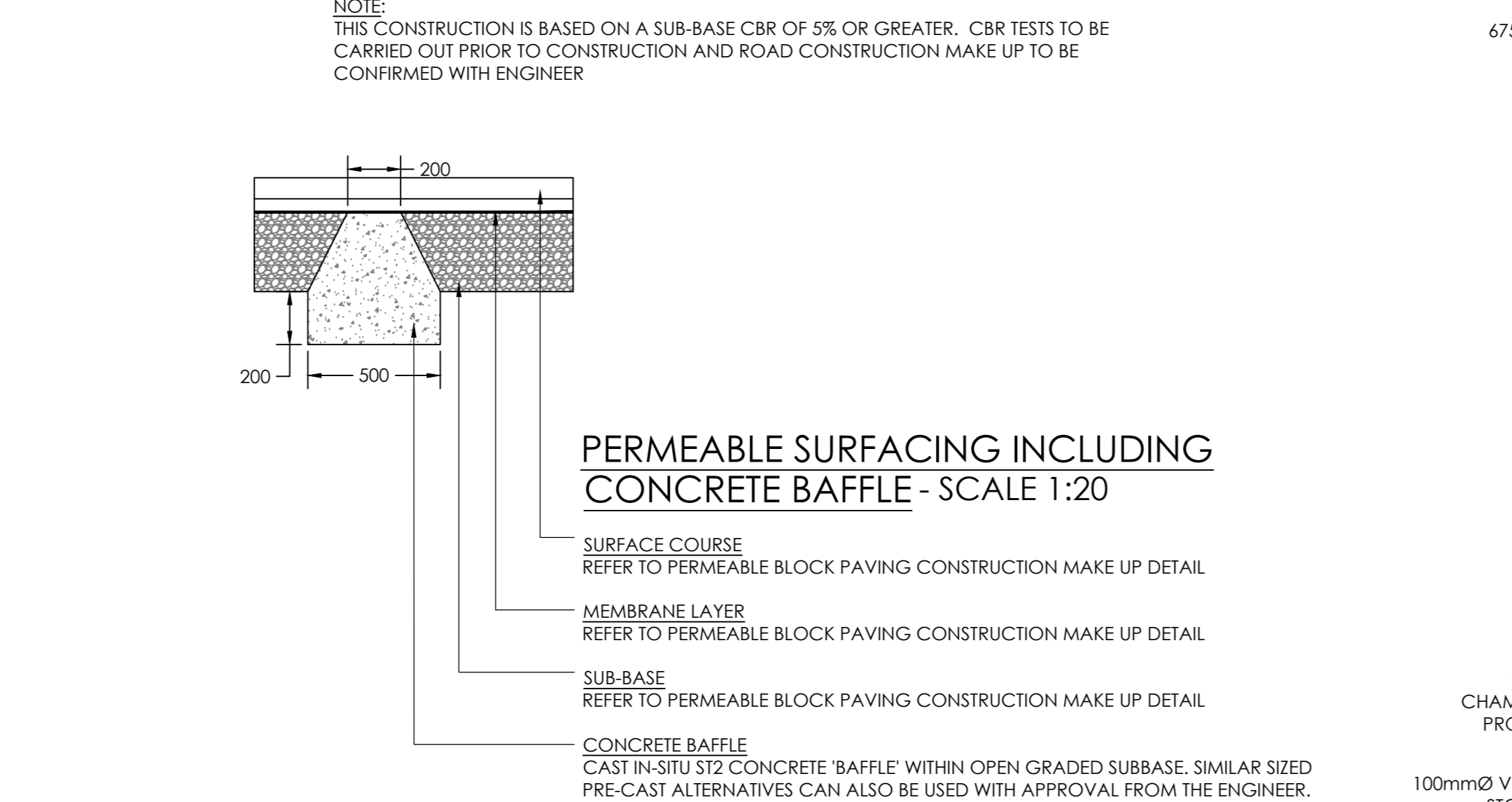
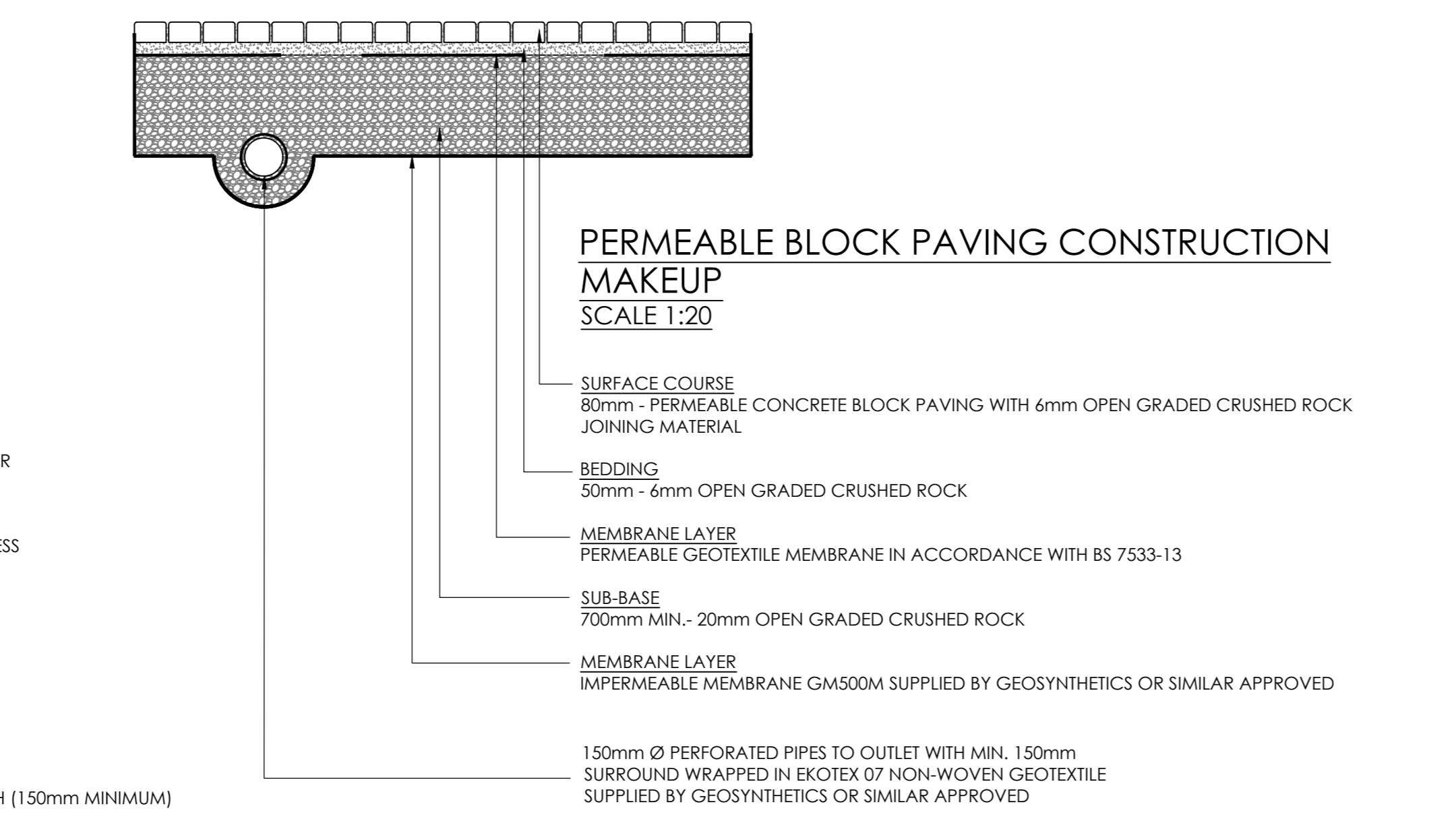
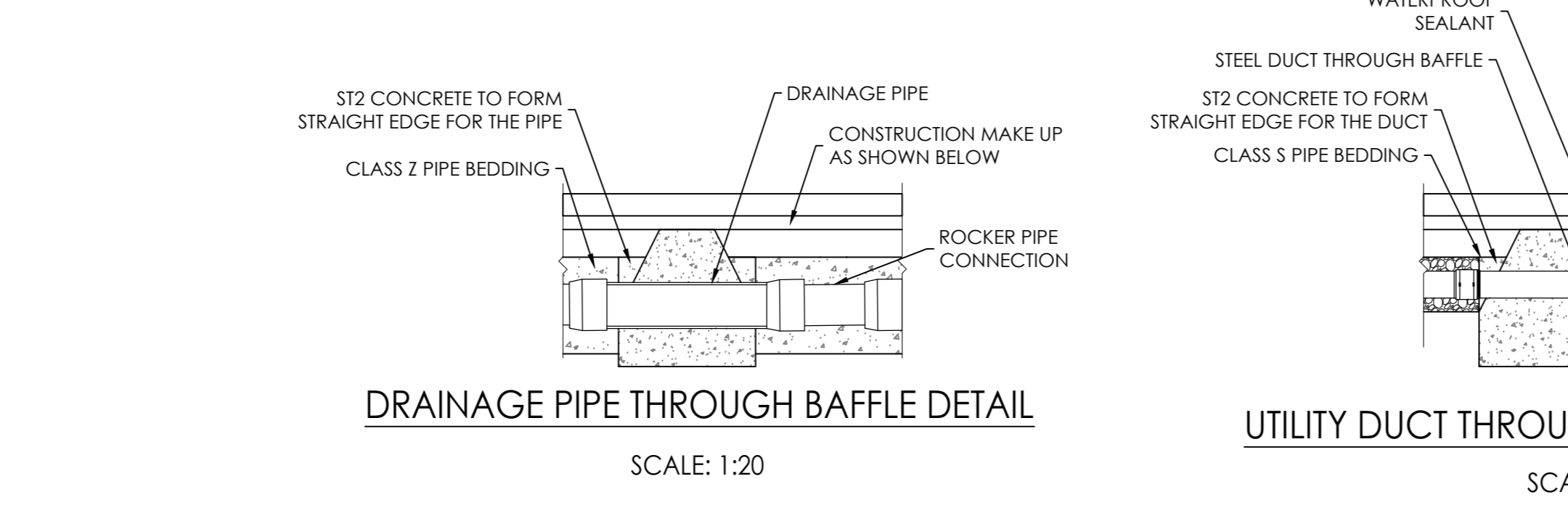
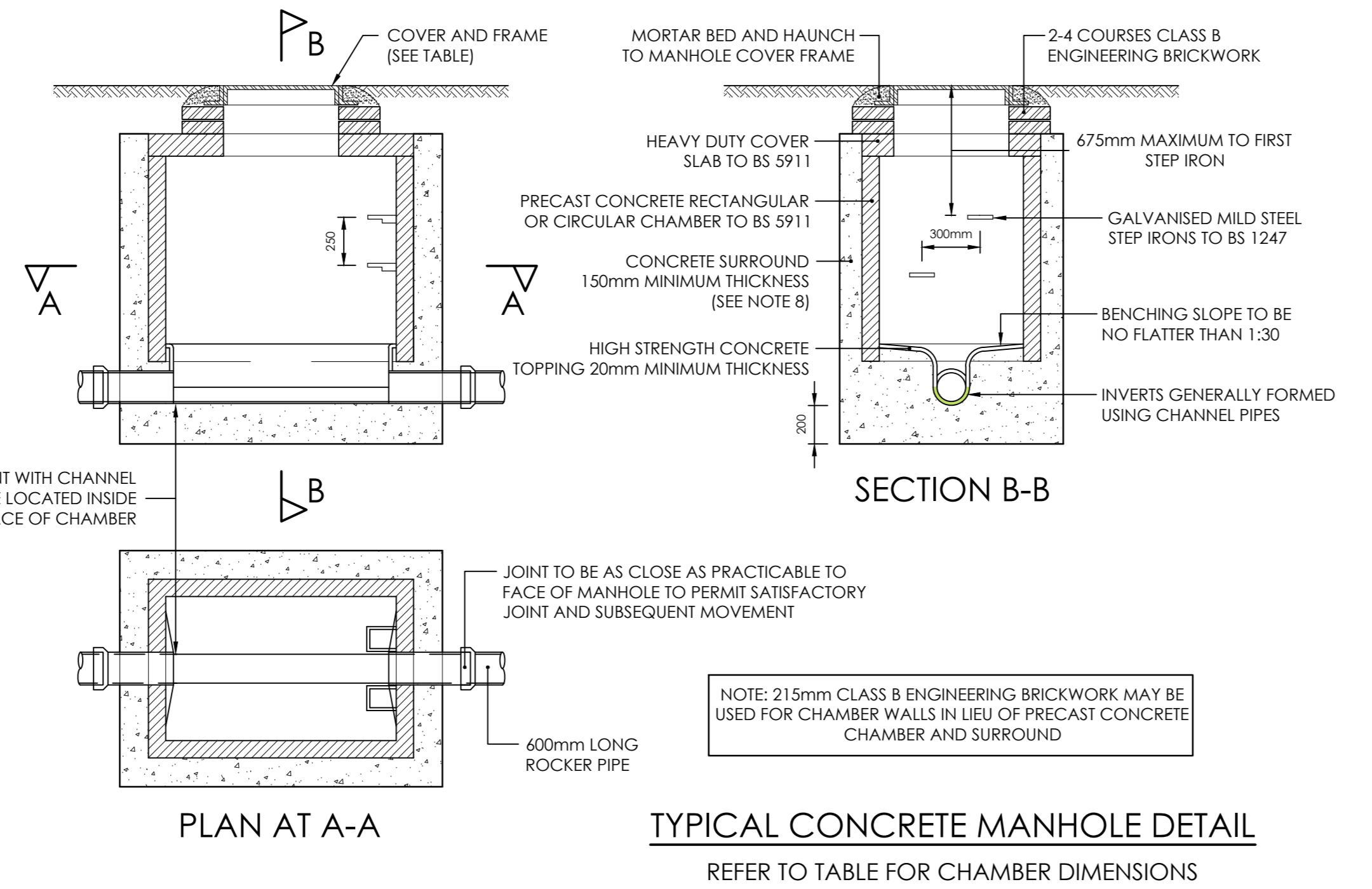

HYDROBRAKE UNIT DIMENSIONS	
CTL-SHE-0049-1000-0800-1000	
A	265
B	110
C	55
D	650
E	300
F	505

HYDROBRAKE UNIT TECHNICAL SPECIFICATION		
	CTL-SHE-0049-1000-0800-1000	
CONTROL POINT	DESIGN HEAD (m)	FLOW (l/s)
PRIMARY DESIGN	0.800	1.000
FLUSH-FLO	0.215	0.927
KICK-FLO	0.437	0.764
MEAN-FLO		0.839

REV	DATE	AMENDMENT DETAILS	DRAWN	APPROVED

PROJECT: MEDWAY LOSE, CHELMSFORD  
 DRAWING TITLE: DRAINAGE STANDARD DETAILS  
 CLIENT: SJT DEVELOPMENTS

DATE: 03.08.23  
 DRAWING STATUS: INFORMATION  
 SCALES: N.T.S.  
 DESIGNED: JG  
 CHECKED: JPP  
 APPROVED: GS

2709  
 02/002

www.createconsultingengineers.co.uk

ORIGINAL SHEET SIZE - A0 Landscape  
 DO NOT SCALE

# Transport Statement



<b>Ref</b>	JTP 634
<b>Site Name</b>	Medway Close, Chelmsford
<b>Date</b>	December 2022

## Quality Assurance

Site name: Medway Close, Chelmsford

Client name: Chelmsford City Council

Type of report: Transport Statement

Prepared and Reviewed by: Steve Amann BSc (Hons) MSc (Eng)

Signed 

Date: December 2022

# Medway Close Chelmsford

## Table of Contents

<b>1</b>	<b>INTRODUCTION.....</b>	<b>1</b>
	Brief.....	1
	Background.....	1
<b>2</b>	<b>SITE ASSESSMENT .....</b>	<b>2</b>
	Existing Information.....	2
	Public Transport Information.....	2
	Walking and Cycling Assessment.....	2
	Safety Considerations and Accident Analysis.....	3
<b>3</b>	<b>POLICY BACKGROUND .....</b>	<b>4</b>
	National Policy .....	4
	The National Planning Policy Framework (NPPF) .....	4
	Promoting Sustainable Transport.....	4
	Local Policy.....	5
	Development Management Policy .....	5
<b>4</b>	<b>DEVELOPMENT PROPOSALS.....</b>	<b>7</b>
	Description of Proposal .....	7
	Trip Generation.....	7
	Vehicle Parking .....	8
	Local Parking Demand .....	8
	Access and Servicing .....	9
<b>5</b>	<b>SUMMARY AND CONCLUSIONS .....</b>	<b>11</b>
	Summary.....	11
	Conclusions.....	11

## Appendices

Appendix 1	Site Location
Appendix 2	Public Transport Information
Appendix 3	Illustrative Development Proposals
Appendix 4	TRICS Data
Appendix 5	Parking Survey
Appendix 6	Vehicle Tracking



# Medway Close Chelmsford

---

## 1 Introduction

### Brief

- 1.1 Journey Transport Planning Ltd has been instructed by Chelmsford City Council to undertake a Transport Statement in support of a full planning application to Chelmsford City Council pursuant to proposals for a residential development for 6 dwellings (C3 use), hard and soft landscaping and associated parking and infrastructure on land to the west of Medway Close, Chelmsford. The location of the site is illustrated in **Appendix 1**.

### Background

- 1.2 This Transport Statement provides a summary of investigations at the site and its access pursuant to demonstrating the proposal will not have a detrimental impact on highway safety or capacity in the vicinity of the site and moreover that the proposal is suitably located for access via means other than the private car.
- 1.3 The following matters are considered in this appraisal:
- Site Assessment
  - National and Local Policy Review
  - Development Proposals and assessment of the traffic impact of the proposal
  - Parking assessment and servicing appraisal

# Medway Close Chelmsford

## 2 Site Assessment

### Existing Information

- 2.1 The proposal site is located on the site of an existing garage complex off Medway Close, Chelmsford. The site location is shown in **Appendix 1**.
- 2.2 Access to the site is proposed by way the existing access drive from Medway Close. This access is currently 3.5m wide at its junction with Medway Close and varies in width at around 4m along its length.
- 2.3 Visibility from the access onto Medway Close is achievable for at least 2.4m by 43m in both directions in accordance with the standards set out in the Manual for Streets for a 30mph road.

### Public Transport Information

- 2.4 Public transport availability in the vicinity of the site has been examined and a regular bus service operate along Avon Road and Roxwell Road at existing stops within 400m of the site. The services are operated by First Essex and Arriva and provide regular timetabled services to Chelmsford Bus Station. The services is summarised in Table 2.1 below and full details of the service can be found in **Appendix 2**.

**Table 2.1 Medway Close Bus Services**

Service Number	Route	Frequency
32	Ongar - Chelmsford	Two Hourly
59	Harlow-Chelmsford	Hourly

- 2.5 The available public transport services in the vicinity of the site represent a reasonable level of service and as such the site is considered to be accessible by bus based public transport.

### Walking and Cycling Assessment

- 2.6 Cycling has the potential to substitute for short car trips, particularly those less than five kilometres. Cycle access to the proposal has been considered in detail. For the purposes of cycle accessibility, a cycling time of 20 minutes, which equates to five kilometres at an average speed of 15kph, has been assumed.
- 2.7 The five kilometre catchment area of the proposal site includes Writtle and much of the built area of Chelmsford City and as such is within reasonable cycling distance of a wide range of associated facilities, amenities and essential services including nursery, primary, secondary and further and higher education establishments, the rail and bus station and the City Centre.
- 2.8 The roads in the vicinity are of a good quality and due to the relatively flat nature of the area, are considered suitable for cycling. The site is also within easy reach of an existing off road cycle route into Chelmsford City Centre which can be reached from the end of Beaches Drive to the south. This provides a safe, signed off-road cycle connection into Chelmsford City, the rail station, and the retail centre.

## Medway Close Chelmsford

---

- 2.9 In consideration of the site location and its connections with the wider area, the site offers excellent opportunities for access by bike.
- 2.10 With respect to pedestrian access walking offers potential to replace short car trips, particularly those under 2km and is generally considered the maximum acceptable distance to directly access any local facility or amenity.
- 2.11 The site is in walking distance of the adjacent bus stops, a petrol filling station with convenience store and local schools.
- 2.12 In consideration of the above, the site is suitably located in accessibility terms by cycle and public transport and provides opportunities for access via means other than the private car.

### Safety Considerations and Accident Analysis

- 2.13 The accident record in the vicinity of the site has been considered and the Essex County Council Collision database indicates that there have been five accidents in the vicinity in the latest available 3 year period between October 2019 and October 2022. Three of the accidents were classified as serious and the remaining as slight. All five incidents took place in along Chignall Road to the east in sperate locations.
- 2.14 Given that there was no clustering or common causal factors, there is are considered to be specific highway safety issue in the vicinity of the site
- 2.15 The proposals by virtue of their very limited impact are very unlikely to have a material impact on that record.

## 3 Policy Background

### National Policy

- 3.1 Relevant policy guidance relating to new development, and transport and land use planning is set out at national level in the following document:
- the National Planning Policy Framework
- 3.2 This document set the context in which the proposals have been assessed.

### The National Planning Policy Framework (NPPF)

- 3.3 The National Planning Policy Framework (NPPF, 2021) in this document the government sets out its core principles for the planning system in England.
- 3.4 The purpose of the planning system is to contribute to the achievement of sustainable development. At a very high level, the objective of sustainable development can be summarised as meeting the needs of the present without compromising the ability of future generations to meet their own needs.

### Promoting Sustainable Transport

- 3.5 The NPPF in promoting sustainable transport considers that for sites to be allocated for development in plans, or specific applications for development, it should be ensured that:
- A. *appropriate opportunities to promote sustainable transport modes can be – or have been – taken up, given the type of development and its location;*
  - B. *safe and suitable access to the site can be achieved for all users; and*
  - C. *any significant impacts from the development on the transport network (in terms of capacity and congestion), or on highway safety, can be cost effectively mitigated to an acceptable degree.*
- 3.6 The framework goes on to re-iterate that **Development should only be prevented or refused on highways grounds if there would be an unacceptable impact on highway safety, or the residual cumulative impacts on the road network would be severe.**
- 3.7 The NPPF sets out in the context of applications for development that they should:
- A. *give priority first to pedestrian and cycle movements, both within the scheme and with neighbouring areas; and second – so far as possible – to facilitating access to high quality public transport, with layouts that maximise the catchment area for bus or other public transport services, and appropriate facilities that encourage public transport use;*
  - B. *address the needs of people with disabilities and reduced mobility in relation to all modes of transport;*
  - C. *create places that are safe, secure and attractive – which minimise the scope for conflicts between pedestrians, cyclists and vehicles, avoid unnecessary street clutter, and respond to local character and design standards;*
  - D. *allow for the efficient delivery of goods, and access by service and emergency vehicles; and*

## Medway Close Chelmsford

---

- E. *be designed to enable charging of plug-in and other ultra-low emission vehicles in safe, accessible and convenient locations.*
- 3.8 The chapter concludes that ... All developments that will generate significant amounts of movement should be required to provide a travel plan, and the application should be supported by a transport statement or transport assessment so that the likely impacts of the proposal can be assessed.

### Local Policy

- 3.9 The following local policy document constitutes the development plan for Chelmsford City Council:
- The Chelmsford Local Plan 2013-2036
  - Parking Standards Design and Good Practice 2009 (Essex Planning Officers Association) and subsequent Chelmsford City Council adopted standards
  - Development Management Policies, Essex County Council February 2011
- 3.10 The Chelmsford Local Plan sets out the policy, aims and objectives for new development and sustainable transport that support the guidance set out in the NPPF and seeks to develop a sustainable, integrated transport system for the area, which provides necessary access to facilities, services and goods with less dependence on cars and less impact on the environment.
- 3.11 Policy DM 27 - Parking Standards at Developments States that: The Council will have regard to the vehicle parking standards set out in the Essex Parking Standards - Design and Good Practice (2009), or as subsequently amended, when determining planning applications. Proposals which provide below these standards should be supported by evidence detailing the local circumstances that justify deviation from the standard.
- 3.12 The advice contained in the national and local policy documents has been fully considered during the development of this proposal. It is considered that the proposal is in accordance with the aims and objectives of transport policy as it applies to both its location and the use proposed.

### Development Management Policy

- 3.13 Essex County Council (ECC) set out in their publication, Development Management Policies (DMP) Feb 2011, that access to development sites should be considered against the Essex Functional Route Hierarchy.
- 3.14 Medway Close, which provides access to the site, is defined within the Functional Route Hierarchy as an Other Route within the defined settlement and as such there are policy restrictions with respect to access proposals for development. Given its location, the proposal site access is governed by Policy DM4 of the DMP, which states that the Highway Authority will protect the function of other routes by:
- Ensuring that new access points will be designed and constructed in accordance with the current standards
  - Requiring improvements to existing substandard access.

## Medway Close Chelmsford

---

- 3.15 The aims and objectives of the DMP have been complied with in the development of this proposal and the development being considered accords with that policy.

# Medway Close Chelmsford

## 4 Development Proposals

### Description of Proposal

- 4.1 The proposals consider a residential development for 5 four bed roomed dwellings and one single bed dwelling (C3 use), hard and soft landscaping and associated parking and infrastructure.
- 4.2 A layout plan of the proposed development is shown in **Appendix 3** and indicates the principal point of access to the site and the general site layout.
- 4.3 As a part of the proposals the access will be widened out at its entry to form a 5.5m wide entrance for at least 6m into the access road.

### Trip Generation

- 4.4 In accordance with standard transport assessment guidelines, the proposals have been considered with respect to the likely level of trips that could be generated and the impact they would have on the local highway network.
- 4.5 The travel demand that could be associated with the proposal has been considered in detail and assessed utilising data from the TRICS trip generation database. Sites within the database have been interrogated to consider sites that are similar in land use, location and size to the proposal being considered.
- 4.6 The TRICS 7.9.3 trip generation database has been interrogated to assess the likely number of vehicular trips that could be associated with nine private flats, representing the proposed development.
- 4.7 **Table 4.1** summarises the trip generation rates and provides an estimate of vehicular movements associated with the development proposals.

**Table 4.1 Residential Use Trip Generation Summary**

	AM Peak (08:00-09:00)		PM Peak (17:00-18:00)		Daily Trips 07:00-19:00	
	Arrivals	Departures	Arrivals	Departures	Arrivals	Departures
Trip Rate per Dwelling	0.154	0.321	0.303	0.167	2.342	2.385
Trips per 6 dwellings	1	2	2	1	14	14

- 4.8 **Table 4.1** indicates that the proposed redevelopment could result 3 trips in the AM peak and 3 trips in the PM peak and 28 movements over a typical day.
- 4.9 Given the very low level of vehicular trips that could be generated by the proposals and the opportunities to access the site via means other than the private car, the development will not have a detrimental impact on the operation of the local road network in the vicinity of the site and can be accommodated in terms of capacity and highway safety. Given the existing garage use, the development will not result in an intensification of use of the access
- 4.10 The TRICS data is held in **Appendix 4**.

# Medway Close Chelmsford

## Vehicle Parking

- 4.11 The car parking requirements of the proposal have been considered in the context of the requirements set out by Chelmsford City Council in accordance with the following minimum requirements:
- One space per one bed dwelling
  - Two spaces per 2 + Bed Dwelling
  - Visitor Parking 0.25 spaces per dwelling
- 4.12 The proposals comprise 5 four bedroomed dwellings and 1 one bedroomed dwelling and as such 11 allocated spaces are proposed with a further 3 visitor parking spaces in accordance with the guidance.
- 4.13 All spaces are proposed at either 2.9m by 5.5m where perpendicular or at 6.0m by 2.9m where parallel provision is proposed. All spaces are accessible without the need to reverse onto the highway.
- 4.14 As a part of the proposals each dwelling will have a cycle parking space in accordance with current standards.

## Local Parking Demand

- 4.15 Following pre-application discussions, the Highway Authority raised concerns with respect to the impact of the loss of car parking provision on the locally available on-street supply and whether the additional demand could be accommodated within the capacity available.
- 4.16 It is understood from discussions with Chelmsford City Council, that the garages are no longer let and as such their proposed removal will not impact on parking supply and the foregoing surveys, already include any impact that could be associated with their removal.
- 4.17 Nonetheless, in order to provide a robust assessment, the availability and utilisation of on-street car parking in the vicinity has been surveyed utilising the Lambeth Parking survey methodology. The surveys were undertaken 29<sup>th</sup> and 30<sup>th</sup> November and 3<sup>rd</sup> of December 2022.
- 4.18 The survey area included all roads within 100m of the site. In accordance with the Lambeth parking survey methodology with available spaces were identified where they are not subject to legal or practical restrictions.
- 4.19 The plan attached at **Appendix 5** illustrates the available parking within the surveyed area. The surveys were undertaken for the following times
- Tuesday                    09:00, 13:00, 16:00
  - Wednesday                09:00, 13:00, 16:00
  - Saturday                    09:00, 13:00, 16:00
- 4.20 The results of the surveys are summarised in Table 4.1 below



# Medway Close Chelmsford

**Table 4.1 Medway Close Parking Beat Survey Summary**

Time Period	On Street Spaces		%age Utilisation
	Spaces Available	Spaces Utilised	
Tues 09:00	84	31	37%
Tues 13:00	84	35	42%
Tues 16:00	84	34	40%
Weds 09:00	84	31	37%
Weds 13:00	84	36	43%
Weds 16:00	84	32	38%
Sat 09:00	84	34	40%
Sat 13:00	84	34	40%
Sat 16:00	84	29	35%

- 4.21 The surveys identify that within 100m of the site there are a total of 84 available legally usable parking spaces not subject to restriction.
- 4.22 During the surveyed days and time periods the data indicates that the maximum utilisation was observed at 13:00 on a Tuesday where 35 parked vehicles were surveyed representing a space utilisation of 42% leaving 49 free spaces. At all other times the observed utilisation was between 29% and 40%.
- 4.23 Given the foregoing, the proposals will not have an impact on the existing available on-street supply and would not result in any measured local parking stress.
- 4.24 The parking surveys and plan held in **Appendix 5**.

## Access and Servicing

- 4.25 The main access to the proposed development is proposed via the existing access to the garages directly from Medway Close. Visibility at the access is achievable at 2.4m by 43m in both directions as required for a 30mph road under Manual for Streets guidance.
- 4.26 The access will be widened out to 5.5m for the initial 6m into the access. The remainder of the access will be provided as a non-adopted access drive with a minimum width of 3.7m to allow for emergency access. The existing kerb will be widened to accommodate the drive with an appropriate drop kerbed crossing.

## Medway Close Chelmsford

---

- 4.27 A vehicle tracking assessment has been undertaken and demonstrates that refuse and emergency fire vehicles can enter and exit the site in forward gear. The vehicle tracking assessment is held in **Appendix 6**.

## Medway Close Chelmsford

---

# 5 Summary and Conclusions

## Summary

- 5.1 This Transport Statement has been provided in support of a full planning application to Chelmsford City Council for proposals for the redevelopment of land and buildings in Medway Close, Chelmsford for the purposes of 6 dwellings, parking and access.
- 5.2 The TRICS trip generation assessment demonstrates that the proposed development would lead to a minimal increase in vehicular trips associated with the site.
- 5.3 The traffic generated by the proposal can be accommodated via the existing access improved arrangements without having a detrimental impact on the operation of the local highway network by virtue of either highway capacity or highway safety.
- 5.4 The site is considered to be in an accessible location for the purposes of access via means other than the private car.
- 5.5 The proposed change of use will incorporate car and cycle parking in accordance with Chelmsford City Council requirements.
- 5.6 The potential displaced parking pressure on local on-street parking that could be created by the development can easily be accommodated by the existing on-street car parking supply without having a detrimental impact in terms of parking stress.
- 5.7 The delivery and emergency manoeuvring requirements for the proposals can be undertaken in accordance with Chelmsford City Council requirements.

## Conclusions

- 5.8 This Transport Statement demonstrates that the proposals have been developed in accordance with the aims and objectives of current national and local policy as it relates to transport and will not have a significant or severe impact on the efficiency or safety of the local transport network.
- 5.9 In view of the foregoing, it is considered that there are no substantive highway or transportation reasons why the proposals as submitted should not be permitted.



**Appendix 1**  
**Site Location**

This drawing is copyright © and must not be reproduced in whole or part without obtaining written authority from John Finch Partnership.  
Do not scale from this drawing.  
All dimensions to be checked on site.  
Refer any discrepancies to the project Architect.

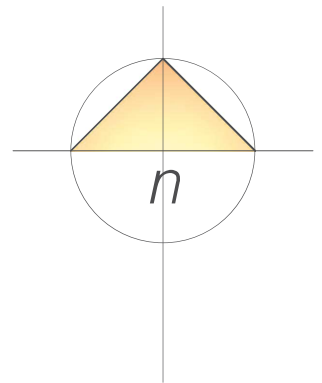

revision

issue

PLANNING

client

Chelmsford City Council

project

Medway Close, Chelmsford

title

Location Plan

**john finch partnership**  
chartered architects & town planning consultants

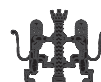

88 Broomfield Road  
Chelmsford CM1 1SS  
01245 354319/250780  
admin@johnfinchpartnership.co.uk

www.johnfinchpartnership.co.uk

date 08.11.22 scale 1:1250 @ A4

drawn jm/jh checked jm

dwg no 3556:01 revision E

## Location plan

A4 SHEET @ 1:1250

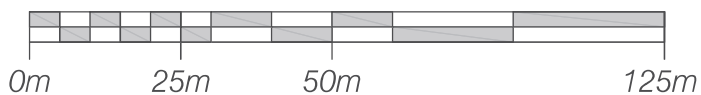



**Appendix 2**  
**Public Transport Information**

## First 32 Ongar-Chelmsford

**Mondays to Fridays** from 30 October 2022

	32	32	32	32	32	32	32
	Sch	NSch					
Ongar, Two Brewers	0717	0732	0957	1157	1357	1707	1843
High Ongar, Church	0727	0738	1003	1203	1403	1713	1848
Blackmore, The Green	0738	0747	1012	1212	1412	1722	1856
Highwood, The Green Man	0747	0756	1021	1221	1421	1731	1904
Oxney Green, Ongar Road	0751	0800	1025	1225	1425	1735	1908
Writtle, Writtle Green	0755	0803	1028	1228	1428	1738	1910
Chelmsford, South Lodge Hotel	0806	0810	1035	1235	1435	1745	1916
Chelmsford, Bus Station Stand 9	0820	-	1045	1245	1445	-	-
Chelmsford, St John Payne School	0829	-	-	-	-	-	-
Chelmsford, Bus Station Stand 6	-	0817	-	-	-	1752	1921
Chignall Estate, Trent Road Shops	-	-	1055	1255	1455	-	-

### Notes

**NSch** this journey runs during school holidays only

**Sch** this journey runs on schooldays only

## First 32 Ongar-Chelmsford

**Saturdays** from 30 October 2022

	32	32	32	32	32	32
Ongar, Two Brewers	0732	0957	1157	1357	1557	1841
High Ongar, Church	0738	1003	1203	1403	1603	1846
Blackmore, The Green	0747	1012	1212	1412	1612	1854
Highwood, The Green Man	0756	1021	1221	1421	1621	1902
Oxney Green, Ongar Road	0800	1025	1225	1425	1625	1906
Writtle, Writtle Green	0803	1028	1228	1428	1628	1908
Chelmsford, South Lodge Hotel	0810	1035	1235	1435	1635	1914
Chelmsford, Bus Station Stand 6	0817	-	-	-	-	1919
Chelmsford, Bus Station Stand 9	-	1045	1245	1445	1645	-
Chignall Estate, Trent Road Shops	-	1055	1255	1455	1655	-

## First 32 Chelmsford-Ongar

**Mondays to Fridays** from 30 October 2022

	32	32	32	32	32	32	32	32
						Sch	NSch	
Chignall Estate, Trent Road Shops	-	0900	1100	1300	1500	-	-	-
Chelmsford, St John Payne School	-	-	-	-	-	1558	-	-
Chelmsford, Bus Station Stand 6	0637	0913	1113	1313	1511	1615	1615	1757
Chelmsford, Rail Station Stand 11	0638	0914	1114	1314	-	1616	1616	1758
Chelmsford, BBC Essex	0642	0921	1121	1321	-	1626	1626	1808
Writtle, Writtle Green	0647	0926	1126	1326	-	1633	1633	1813
Oxney Green, Ongar Road	0649	0928	1128	1328	-	1635	1635	1815
Highwood, The Green Man	0653	0932	1132	1332	-	1639	1639	1819
Blackmore, The Green	0701	0940	1140	1340	-	1648	1648	1827
High Ongar, Church	0709	0949	1149	1349	-	1656	1656	1835
Ongar, Two Brewers	0714	0954	1154	1354	-	1702	1702	1840

### Notes

**NSch** this journey runs during school holidays only

**Sch** this journey runs on schooldays only

## First 32 Chelmsford-Ongar

Saturdays from 30 October 2022

32 32 32 32 32 32 32

<b>Chignall Estate</b> , Trent Road Shops	-	0900	1100	1300	1500	1700	-
<b>Chelmsford</b> , Bus Station Stand 6	0637	0913	1113	1313	1513	1711	1757
<b>Chelmsford</b> , Rail Station Stand 11	0638	0914	1114	1314	1514	-	1758
<b>Chelmsford</b> , BBC Essex	0642	0921	1121	1321	1521	-	1805
<b>Writtle</b> , Writtle Green	0647	0926	1126	1326	1526	-	1810
<b>Oxney Green</b> , Ongar Road	0649	0928	1128	1328	1528	-	1812
<b>Highwood</b> , The Green Man	0653	0932	1132	1332	1532	-	1816
<b>Blackmore</b> , The Green	0701	0940	1140	1340	1540	-	1824
<b>High Ongar</b> , Church	0709	0949	1149	1349	1549	-	1832
<b>Ongar</b> , Two Brewers	0714	0954	1154	1354	1554	-	1838



## Arriva 59 Harlow-Chelmsford

### Mondays to Fridays from 11 April 2021

	59	59	59	59	59	59	59	59	59	59	59	59	59
<b>Harlow</b> , Bus Station Stand 11	0542	0655	0730	0905	1005	1105	1205	1305	1405	1505	1605	1720	1820
<b>Old Harlow</b> , Post Office	0549	0703	0740	0913	1013	1113	1213	1313	1413	1517	1617	1732	1828
<b>Lower Sheering</b> , Gilden Way	0552	0706	0743	0916	1016	1116	1216	1316	1416	1521	1621	1736	1831
<b>Sheering</b> , The Cock	0556	0710	0746	0920	1020	1120	1220	1320	1420	1525	1625	1740	1835
<b>Hatfield Heath</b> , The White Horse	0559	0713	0751	0923	1023	1123	1223	1323	1423	1529	1629	1744	1838
<b>White Roding</b> , The Black Horse	0603	0717	0755	0928	1028	1128	1228	1328	1428	1534	1634	1749	1843
<b>Leaden Roding</b> , Village Hall	0607	0722	0800	0932	1032	1132	1232	1332	1432	1538	1638	1753	1847
<b>Margaret Roding</b> , Marks Hall Lane	0610	0725	0803	0935	1035	1135	1235	1335	1435	1541	1641	1756	1850
<b>Boyton Cross</b> , Boyton Cross Lane	0615	0731	0809	0941	1041	1141	1241	1341	1441	1547	1647	1802	1856
<b>Roxwell</b> , The Hare	0617	0733	0811	0943	1043	1143	1243	1343	1443	1549	1649	1804	1858
<b>Chelmsford</b> , Rail Station Stand 11	0625	0742	0825	0952	1052	1152	1252	1352	1452	1600	1700	1815	1907
<b>Chelmsford</b> , Anglia Ruskin University	-	0748	0831	0958	1058	1158	1258	1358	1458	1606	1706	1821	1912

## Arriva 59 Harlow-Chelmsford

### Saturdays from 11 April 2021

	59	59	59	59	59	59	59	59	59	59	59
<b>Harlow</b> , Bus Station Stand 11	0655	0805	0905	1005	1105	1205	1305	1405	1505	1605	1705
<b>Old Harlow</b> , Post Office	0703	0813	0913	1013	1113	1213	1313	1413	1513	1613	1713
<b>Lower Sheering</b> , Gilden Way	0706	0816	0916	1016	1116	1216	1316	1416	1516	1616	1716
<b>Sheering</b> , The Cock	0710	0820	0920	1020	1120	1220	1320	1420	1520	1620	1720
<b>Hatfield Heath</b> , The White Horse	0713	0823	0923	1023	1123	1223	1323	1423	1523	1623	1723
<b>White Roding</b> , The Black Horse	0718	0828	0928	1028	1128	1228	1328	1428	1528	1628	1728
<b>Leaden Roding</b> , Village Hall	0722	0832	0932	1032	1132	1232	1332	1432	1532	1632	1732
<b>Margaret Roding</b> , Marks Hall Lane	0725	0835	0935	1035	1135	1235	1335	1435	1535	1635	1735
<b>Boyton Cross</b> , Boyton Cross Lane	0731	0841	0941	1041	1141	1241	1341	1441	1541	1641	1741
<b>Roxwell</b> , The Hare	0733	0843	0943	1043	1143	1243	1343	1443	1543	1643	1743
<b>Chelmsford</b> , Rail Station Stand 11	0742	0852	0952	1052	1152	1252	1352	1452	1552	1652	1752
<b>Chelmsford</b> , Anglia Ruskin University	0748	0858	0958	1058	1158	1258	1358	1458	1558	1658	1758

## Arriva 59 Harlow-Chelmsford

### Sundays and Public Holidays from 11 April 2021

	59	59	59	59	59	59
<b>Harlow</b> , Bus Station Stand 11	0855	1055	1255	1455	1655	1855
<b>Old Harlow</b> , Post Office	0903	1103	1303	1503	1703	1903
<b>Lower Sheering</b> , Gilden Way	0907	1107	1307	1507	1707	1907
<b>Sheering</b> , The Cock	0912	1112	1312	1512	1712	1912
<b>Hatfield Heath</b> , The White Horse	0915	1115	1315	1515	1715	1915
<b>White Roding</b> , The Black Horse	0921	1121	1321	1521	1721	1921
<b>Leaden Roding</b> , Village Hall	0925	1125	1325	1525	1725	1925
<b>Margaret Roding</b> , Marks Hall Lane	0927	1127	1327	1527	1727	1927
<b>Boyton Cross</b> , Boyton Cross Lane	0932	1132	1332	1532	1732	1932
<b>Roxwell</b> , The Hare	0934	1134	1334	1534	1734	1934
<b>Chelmsford</b> , Rail Station Stand 11	0945	1145	1345	1545	1745	1945

## Arriva 59 Chelmsford-Harlow

**Mondays to Fridays** from 11 April 2021

	59	59	59	59	59	59	59	59	59	59	59	59	59	59
<b>Chelmsford</b> , Anglia Ruskin University	-	-	0754	0854	1004	1104	1204	1304	1404	1504	1614	1714	1829	1920
<b>Chelmsford</b> , Bus Station Stand 9	0605	0635	0800	0900	1010	1110	1210	1310	1410	1510	1620	1720	1835	1926
<b>Roxwell</b> , The Hare	0615	0646	0811	0911	1021	1121	1221	1321	1421	1521	1631	1731	1846	1937
<b>Boyton Cross</b> , Boyton Cross Lane	0617	0649	0814	0914	1024	1124	1224	1324	1424	1524	1634	1734	1849	1940
<b>Margaret Roding</b> , Marks Hall Lane	0622	0654	0819	0919	1029	1129	1229	1329	1429	1529	1639	1739	1854	1945
<b>Leaden Roding</b> , Village Hall	0624	0656	0821	0921	1031	1131	1231	1331	1431	1531	1641	1741	1856	1947
<b>White Roding</b> , The Black Horse	0628	0700	0825	0925	1035	1135	1235	1335	1435	1535	1645	1745	1900	1951
<b>Hatfield Heath</b> , The White Horse	0633	0705	0830	0930	1040	1140	1240	1340	1440	1540	1650	1750	1905	1956
<b>Sheering</b> , The Cock	0636	0708	0833	0933	1043	1143	1243	1343	1443	1543	1653	1753	1908	1959
<b>Lower Sheering</b> , Gilden Way	0640	0712	0837	0937	1047	1147	1247	1347	1447	1547	1657	1757	1912	2003
<b>Harlow</b> , Bus Station Stand 11	0649	0721	0846	0946	1056	1156	1256	1356	1456	1556	1706	1806	1921	2012

## Arriva 59 Chelmsford-Harlow

**Saturdays** from 11 April 2021

	59	59	59	59	59	59	59	59	59	59	59
<b>Chelmsford</b> , Anglia Ruskin University	0754	0904	1004	1104	1204	1304	1404	1504	1604	1704	1804
<b>Chelmsford</b> , Bus Station Stand 9	0800	0910	1010	1110	1210	1310	1410	1510	1610	1710	1810
<b>Roxwell</b> , The Hare	0811	0921	1021	1121	1221	1321	1421	1521	1621	1721	1821
<b>Boyton Cross</b> , Boyton Cross Lane	0814	0924	1024	1124	1224	1324	1424	1524	1624	1724	1824
<b>Margaret Roding</b> , Marks Hall Lane	0819	0929	1029	1129	1229	1329	1429	1529	1629	1729	1829
<b>Leaden Roding</b> , Village Hall	0821	0931	1031	1131	1231	1331	1431	1531	1631	1731	1831
<b>White Roding</b> , The Black Horse	0825	0935	1035	1135	1235	1335	1435	1535	1635	1735	1835
<b>Hatfield Heath</b> , The White Horse	0830	0940	1040	1140	1240	1340	1440	1540	1640	1740	1840
<b>Sheering</b> , The Cock	0833	0943	1043	1143	1243	1343	1443	1543	1643	1743	1843
<b>Lower Sheering</b> , Gilden Way	0837	0947	1047	1147	1247	1347	1447	1547	1647	1747	1847
<b>Harlow</b> , Bus Station Stand 11	0846	0956	1056	1156	1256	1356	1456	1556	1656	1756	1856

## Arriva 59 Chelmsford-Harlow

**Sundays and Public Holidays** from 11 April 2021

	59	59	59	59	59	59
<b>Chelmsford</b> , Bus Station Stand 9	0955	1155	1355	1555	1755	1955
<b>Roxwell</b> , The Hare	1006	1206	1406	1606	1806	2006
<b>Boyton Cross</b> , Boyton Cross Lane	1008	1208	1408	1608	1808	2008
<b>Margaret Roding</b> , Marks Hall Lane	1013	1213	1413	1613	1813	2013
<b>Leaden Roding</b> , Village Hall	1015	1215	1415	1615	1815	2015
<b>White Roding</b> , The Black Horse	1019	1219	1419	1619	1819	2019
<b>Hatfield Heath</b> , The White Horse	1025	1225	1425	1625	1825	2025
<b>Sheering</b> , The Cock	1028	1228	1428	1628	1828	2028
<b>Lower Sheering</b> , Gilden Way	1033	1233	1433	1633	1833	2033
<b>Harlow</b> , Bus Station Stand 11	1042	1242	1442	1642	1842	2042



**Appendix 3**  
**Development Layout**

A3 SHEET @ 1:500

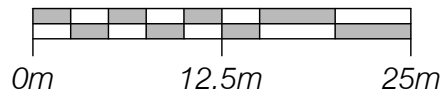

This drawing is copyright © and must not be reproduced in whole or part without obtaining written authority from John Finch Partnership. Do not scale from this drawing. All dimensions to be checked on site. Refer any discrepancies to the project Architect.



**Accommodation Schedule**

Plot No.	Accommodation	Area (m <sup>2</sup> )	Amenity (m <sup>2</sup> )
01	4 Bedroom 7 person house	110	108
02	4 Bedroom 7 person house	110	104
03	4 Bedroom 7 person house	110	104
04	4 Bedroom 7 person house	110	104
05	4 Bedroom 7 person house	110	110
06	1 Bedroom 2 person apartment	60	4
G1/2	Private Double Garage	42	

**Key:**

- Retained Tree
- Proposed Tree
- Permeable gravel driveway
- Concrete pavers
- Cycle Stores
- Bins
- 1800mm h. close boarded timber fence
- 1800mm h. 225mm thick external brick wall

revision

issue

PLANNING

client

Chelmsford City Council

project

Medway Close, Chelmsford

title

Proposed Block Plan

**john finch partnership**  
chartered architects & town planning consultants



88 Broomfield Road  
Chelmsford CM1 1SS  
01245 354319/250780  
admin@johnfinchpartnership.co.uk

www.johnfinchpartnership.co.uk

date 08.11.22 scale 1:500 @ A3

drawn jm/jh checked jm

dwg no 3556:02 revision D

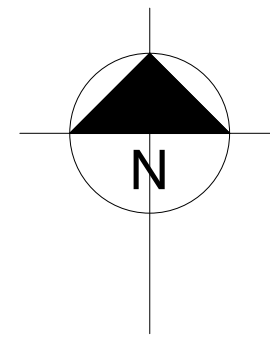

Site Area = 0.23ha



## **Appendix 4**

### **TRICS Data**

Calculation Reference: AUDIT-757101-221208-1226

TRIP RATE CALCULATION SELECTION PARAMETERS:

Land Use : 03 - RESIDENTIAL  
 Category : A - HOUSES PRIVATELY OWNED  
 TOTAL VEHICLES

Selected regions and areas:

02	SOUTH EAST	
	ES EAST SUSSEX	1 days
	MW MEDWAY	1 days
03	SOUTH WEST	
	GS GLOUCESTERSHIRE	1 days
	SM SOMERSET	2 days
04	EAST ANGLIA	
	CA CAMBRIDGESHIRE	1 days
	SF SUFFOLK	2 days
05	EAST MIDLANDS	
	NM WEST NORTHAMPTONSHIRE	1 days
	NN NORTH NORTHAMPTONSHIRE	1 days
07	YORKSHIRE & NORTH LINCOLNSHIRE	
	SY SOUTH YORKSHIRE	2 days
08	NORTH WEST	
	AC CHESHIRE WEST & CHESTER	1 days
09	NORTH	
	TW TYNE & WEAR	1 days

*This section displays the number of survey days per TRICS® sub-region in the selected set*

Primary Filtering selection:

*This data displays the chosen trip rate parameter and its selected range. Only sites that fall within the parameter range are included in the trip rate calculation.*

Parameter: No of Dwellings  
 Actual Range: 8 to 47 (units: )  
 Range Selected by User: 6 to 50 (units: )

Parking Spaces Range: All Surveys Included

Parking Spaces per Dwelling Range: All Surveys Included

Bedrooms per Dwelling Range: All Surveys Included

Percentage of dwellings privately owned: All Surveys Included

Public Transport Provision:

Selection by: Include all surveys

Date Range: 01/01/14 to 22/06/22

*This data displays the range of survey dates selected. Only surveys that were conducted within this date range are included in the trip rate calculation.*

Selected survey days:

Tuesday	4 days
Wednesday	3 days
Thursday	2 days
Friday	5 days

*This data displays the number of selected surveys by day of the week.*

Selected survey types:

Manual count	14 days
Directional ATC Count	0 days

*This data displays the number of manual classified surveys and the number of unclassified ATC surveys, the total adding up to the overall number of surveys in the selected set. Manual surveys are undertaken using staff, whilst ATC surveys are undertaken using machines.*

Selected Locations:

Neighbourhood Centre (PPS6 Local Centre) 14

*This data displays the number of surveys per main location category within the selected set. The main location categories consist of Free Standing, Edge of Town, Suburban Area, Neighbourhood Centre, Edge of Town Centre, Town Centre and Not Known.*

*This data displays the number of surveys per location sub-category within the selected set. The location sub-categories consist of Commercial Zone, Industrial Zone, Development Zone, Residential Zone, Retail Zone, Built-Up Zone, Village, Out of Town, High Street and No Sub Category.*

Secondary Filtering selection:

Use Class:

C3 14 days

*This data displays the number of surveys per Use Class classification within the selected set. The Use Classes Order 2005 has been used for this purpose, which can be found within the Library module of TRICS@.*

Population within 500m Range:

All Surveys Included

Population within 1 mile:

1,000 or Less 2 days  
 1,001 to 5,000 10 days  
 5,001 to 10,000 2 days

*This data displays the number of selected surveys within stated 1-mile radii of population.*

Population within 5 miles:

25,001 to 50,000 3 days  
 50,001 to 75,000 2 days  
 75,001 to 100,000 2 days  
 125,001 to 250,000 5 days  
 250,001 to 500,000 1 days  
 500,001 or More 1 days

*This data displays the number of selected surveys within stated 5-mile radii of population.*

Car ownership within 5 miles:

0.6 to 1.0 5 days  
 1.1 to 1.5 7 days  
 1.6 to 2.0 2 days

*This data displays the number of selected surveys within stated ranges of average cars owned per residential dwelling, within a radius of 5-miles of selected survey sites.*

Travel Plan:

Yes 3 days  
 No 11 days

*This data displays the number of surveys within the selected set that were undertaken at sites with Travel Plans in place, and the number of surveys that were undertaken at sites without Travel Plans.*

PTAL Rating:

No PTAL Present 14 days

*This data displays the number of selected surveys with PTAL Ratings.*

Covid-19 Restrictions Yes At least one survey within the selected data set was undertaken at a time of Covid-19 restrictions

LIST OF SITES relevant to selection parameters

1	AC-03-A-05 MEADOW DRIVE NORTHWICH BARNTON Neighbourhood Centre (PPS6 Local Centre) Village Total No of Dwellings: 40 <i>Survey date: FRIDAY 30/04/21</i>	SEMI -DETACHED & TERRACED	CHESHIRE WEST & CHESTER
2	CA-03-A-07 FIELD END NEAR ELY WITCHFORD Neighbourhood Centre (PPS6 Local Centre) Village Total No of Dwellings: 32 <i>Survey date: THURSDAY 27/05/21</i>	MIXED HOUSES	CAMBRIDGESHIRE
3	ES-03-A-06 BISHOPS LANE RINGMER  Neighbourhood Centre (PPS6 Local Centre) Village Total No of Dwellings: 12 <i>Survey date: WEDNESDAY 16/06/21</i>	MIXED HOUSES	EAST SUSSEX
4	GS-03-A-02 OAKRIDGE NEAR GLOUCESTER HIGHNAM Neighbourhood Centre (PPS6 Local Centre) Village Total No of Dwellings: 40 <i>Survey date: FRIDAY 23/04/21</i>	DETACHED HOUSES	GLOUCESTERSHIRE
5	MW-03-A-01 ROCHESTER ROAD NEAR CHATHAM BURHAM Neighbourhood Centre (PPS6 Local Centre) Village Total No of Dwellings: 8 <i>Survey date: FRIDAY 22/09/17</i>	DETACHED & SEMI -DETACHED	MEDWAY
6	NM-03-A-02 HARLESTONE ROAD NEAR NORTHAMPTON CHAPEL BRAMPTON Neighbourhood Centre (PPS6 Local Centre) Village Total No of Dwellings: 47 <i>Survey date: TUESDAY 20/10/20</i>	DETACHED & SEMI -DETACHED	WEST NORTHAMPTONSHIRE
7	NN-03-A-01 MAIN STREET NEAR WELLINGBOROUGH LITTLE HARROWDEN Neighbourhood Centre (PPS6 Local Centre) Village Total No of Dwellings: 44 <i>Survey date: TUESDAY 20/10/20</i>	MIXED HOUSES & FLATS	NORTH NORTHAMPTONSHIRE
8	SF-03-A-06 BURY ROAD KENTFORD  Neighbourhood Centre (PPS6 Local Centre) Village Total No of Dwellings: 38 <i>Survey date: FRIDAY 22/09/17</i>	DETACHED & SEMI -DETACHED	SUFFOLK



LIST OF SITES relevant to selection parameters (Cont.)

9	SF-03-A-08	MIXED HOUSES	SUFFOLK
	STANNINGFIELD ROAD		
	NEAR BURY ST EDMUNDS		
	GREAT WHELNETHAM		
	Neighbourhood Centre (PPS6 Local Centre)		
	Village		
	Total No of Dwellings:	34	
	Survey date: WEDNESDAY	16/09/20	Survey Type: MANUAL
10	SM-03-A-02	MIXED HOUSES	SOMERSET
	HYDE LANE		
	NEAR TAUNTON		
	CREECH SAINT MICHAEL		
	Neighbourhood Centre (PPS6 Local Centre)		
	Village		
	Total No of Dwellings:	42	
	Survey date: TUESDAY	25/09/18	Survey Type: MANUAL
11	SM-03-A-03	MIXED HOUSES	SOMERSET
	HYDE LANE		
	NEAR TAUNTON		
	CREECH ST MICHAEL		
	Neighbourhood Centre (PPS6 Local Centre)		
	Village		
	Total No of Dwellings:	41	
	Survey date: TUESDAY	25/09/18	Survey Type: MANUAL
12	SY-03-A-02	DETACHED & BUNGALOWS	SOUTH YORKSHIRE
	MANOR ROAD		
	NEAR SHEFFIELD		
	WALES		
	Neighbourhood Centre (PPS6 Local Centre)		
	Village		
	Total No of Dwellings:	25	
	Survey date: THURSDAY	10/09/20	Survey Type: MANUAL
13	SY-03-A-03	BUNGALOWS & DETACHED	SOUTH YORKSHIRE
	CHURCH LANE		
	NEAR BARNSELEY		
	WORSBROUGH		
	Neighbourhood Centre (PPS6 Local Centre)		
	Village		
	Total No of Dwellings:	19	
	Survey date: WEDNESDAY	09/09/20	Survey Type: MANUAL
14	TW-03-A-03	MIXED HOUSES	TYNE & WEAR
	STATION ROAD		
	NEAR NEWCASTLE		
	BACKWORTH		
	Neighbourhood Centre (PPS6 Local Centre)		
	Village		
	Total No of Dwellings:	33	
	Survey date: FRIDAY	13/11/15	Survey Type: MANUAL

*This section provides a list of all survey sites and days in the selected set. For each individual survey site, it displays a unique site reference code and site address, the selected trip rate calculation parameter and its value, the day of the week and date of each survey, and whether the survey was a manual classified count or an ATC count.*

TRIP RATE for Land Use 03 - RESIDENTIAL/A - HOUSES PRIVATELY OWNED  
 TOTAL VEHICLES  
 Calculation factor: 1 DWELLS  
 BOLD print indicates peak (busiest) period

Time Range	ARRIVALS			DEPARTURES			TOTALS		
	No. Days	Ave. DWELLS	Trip Rate	No. Days	Ave. DWELLS	Trip Rate	No. Days	Ave. DWELLS	Trip Rate
00:00 - 01:00									
01:00 - 02:00									
02:00 - 03:00									
03:00 - 04:00									
04:00 - 05:00									
05:00 - 06:00									
06:00 - 07:00									
07:00 - 08:00	14	33	0.088	14	33	0.262	14	33	0.350
08:00 - 09:00	14	33	0.154	14	33	0.321	14	33	0.475
09:00 - 10:00	14	33	0.147	14	33	0.224	14	33	0.371
10:00 - 11:00	14	33	0.167	14	33	0.171	14	33	0.338
11:00 - 12:00	14	33	0.220	14	33	0.198	14	33	0.418
12:00 - 13:00	14	33	0.167	14	33	0.174	14	33	0.341
13:00 - 14:00	14	33	0.187	14	33	0.180	14	33	0.367
14:00 - 15:00	14	33	0.193	14	33	0.178	14	33	0.371
15:00 - 16:00	14	33	0.226	14	33	0.196	14	33	0.422
16:00 - 17:00	14	33	0.248	14	33	0.182	14	33	0.430
17:00 - 18:00	14	33	0.303	14	33	0.167	14	33	0.470
18:00 - 19:00	14	33	0.242	14	33	0.132	14	33	0.374
19:00 - 20:00									
20:00 - 21:00									
21:00 - 22:00									
22:00 - 23:00									
23:00 - 24:00									
<b>Total Rates:</b>			<b>2.342</b>			<b>2.385</b>			<b>4.727</b>

*This section displays the trip rate results based on the selected set of surveys and the selected count type (shown just above the table). It is split by three main columns, representing arrivals trips, departures trips, and total trips (arrivals plus departures). Within each of these main columns are three sub-columns. These display the number of survey days where count data is included (per time period), the average value of the selected trip rate calculation parameter (per time period), and the trip rate result (per time period). Total trip rates (the sum of the column) are also displayed at the foot of the table.*

*To obtain a trip rate, the average (mean) trip rate parameter value (TRP) is first calculated for all selected survey days that have count data available for the stated time period. The average (mean) number of arrivals, departures or totals (whichever applies) is also calculated (COUNT) for all selected survey days that have count data available for the stated time period. Then, the average count is divided by the average trip rate parameter value, and multiplied by the stated calculation factor (shown just above the table and abbreviated here as FACT). So, the method is: COUNT/TRP\*FACT. Trip rates are then rounded to 3 decimal places.*

The survey data, graphs and all associated supporting information, contained within the TRICS Database are published by TRICS Consortium Limited ("the Company") and the Company claims copyright and database rights in this published work. The Company authorises those who possess a current TRICS licence to access the TRICS Database and copy the data contained within the TRICS Database for the licence holders' use only. Any resulting copy must retain all copyrights and other proprietary notices, and any disclaimer contained thereon.

The Company accepts no responsibility for loss which may arise from reliance on data contained in the TRICS Database. [No warranty of any kind, express or implied, is made as to the data contained in the TRICS Database.]

Parameter summary

Trip rate parameter range selected: 8 - 47 (units: )  
 Survey date range: 01/01/14 - 22/06/22  
 Number of weekdays (Monday-Friday): 14  
 Number of Saturdays: 0  
 Number of Sundays: 0  
 Surveys automatically removed from selection: 1  
 Surveys manually removed from selection: 0



*This section displays a quick summary of some of the data filtering selections made by the TRICS® user. The trip rate calculation parameter range of all selected surveys is displayed first, followed by the range of minimum and maximum survey dates selected by the user. Then, the total number of selected weekdays and weekend days in the selected set of surveys are shown. Finally, the number of survey days that have been manually removed from the selected set outside of the standard filtering procedure are displayed.*



**Appendix 5**  
**Parking Plan and Survey**

34111 Chelmsford  
Area 1 - Avon Road, CM1 2JX  
Street Inventory  
Tuesday 29th November 2022



-  Dropped Kerb
-  Disability Permit Bay
-  Bus Stop

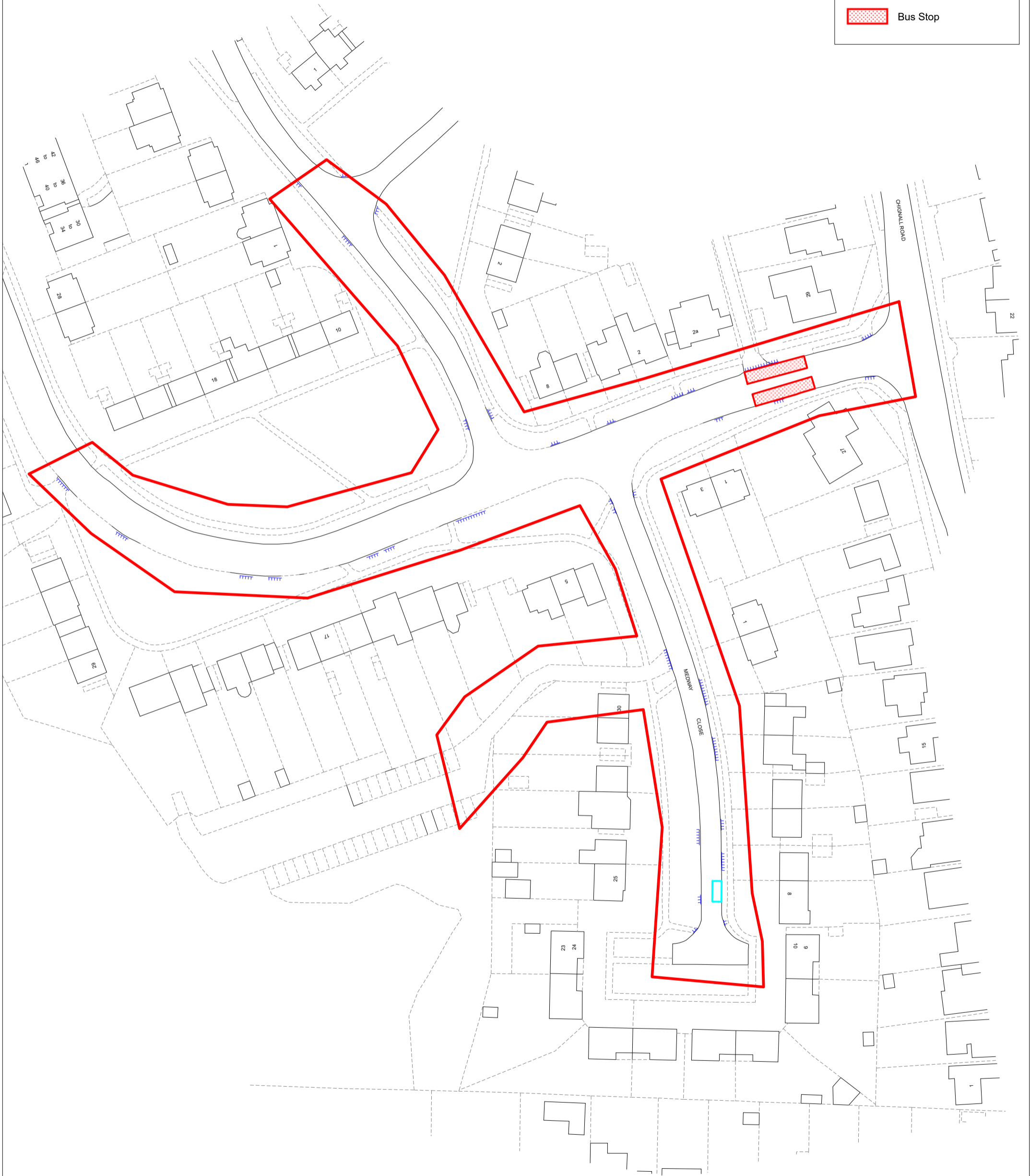

0830 Tuesday 29th	Street	Total Length of Available Kerb Space	Length of Junctions	Length of Bus stops/other	Unrestricted Kerb Space			Double Yellow Line				
					Length (m)	Calculated Spaces	Cars Parked	Stress	Length (m)	Calculated Spaces	Cars Parked	Stress
					The Street	178	5	17	146	29	12	41%
St Michaels Drive	286	5	57	224	44	13	30%					
<b>Total per Beat by restriction</b>					73	25	34%		2	0	0%	
<b>Total per Beat</b>					73	25	34%					

1230 Tuesday 29th	Street	Total Length of Available Kerb Space	Length of Junctions	Length of Bus stops/other	Unrestricted Kerb Space			Double Yellow Line				
					Length (m)	Calculated Spaces	Cars Parked	Stress	Length (m)	Calculated Spaces	Cars Parked	Stress
					The Street	178	5	17	146	29	10	34%
St Michaels Drive	286	5	57	224	44	10	23%					
<b>Total per Beat by restriction</b>					73	20	27%		2	0	0%	
<b>Total per Beat</b>					73	20	27%					

1930 Tuesday 29th	Street	Total Length of Available Kerb Space	Length of Junctions	Length of Bus stops/other	Unrestricted Kerb Space			Double Yellow Line				
					Length (m)	Calculated Spaces	Cars Parked	Stress	Length (m)	Calculated Spaces	Cars Parked	Stress
					The Street	178	5	17	146	29	11	38%
St Michaels Drive	286	5	57	224	44	13	30%					
<b>Total per Beat by restriction</b>					73	24	33%		2	0	0%	
<b>Total per Beat</b>					73	24	33%					

0830 Wednesday	Street	Total Length of Available Kerb Space	Length of Junctions	Length of Bus stops/other	Unrestricted Kerb Space			Double Yellow Line				
					Length (m)	Calculated Spaces	Cars Parked	Stress	Length (m)	Calculated Spaces	Cars Parked	Stress
					The Street	178	5	17	146	29	11	38%
St Michaels Drive	286	5	57	224	44	13	30%					
<b>Total per Beat by restriction</b>					73	24	33%		2	0	0%	
<b>Total per Beat</b>					73	24	33%					

1230 Wednesday	Street	Total Length of Available Kerb Space	Length of Junctions	Length of Bus stops/other	Unrestricted Kerb Space			Double Yellow Line				
					Length (m)	Calculated Spaces	Cars Parked	Stress	Length (m)	Calculated Spaces	Cars Parked	Stress
					The Street	178	5	17	146	29	11	38%
St Michaels Drive	286	5	57	224	44	12	27%					
<b>Total per Beat by restriction</b>					73	23	32%		2	0	0%	
<b>Total per Beat</b>					73	23	32%					

1930 Wednesday	Street	Total Length Available Kerb Space	Length of Junctions	Length of Bus stops/other	Unrestricted Kerb Space			Double Yellow Line				
					Length (m)	Calculated Spaces	Cars Parked	Stress	Length (m)	Calculated Spaces	Cars Parked	Stress
	The Street	178	5	17	146	29	10	34%	10	2	0	0%
	St Michaels Drive	286	5	57	224	44	12	27%				
<b>Total per Beat by restriction</b>						73	22	30%		2	0	0%
<b>Total per Beat</b>						73	22	30%				

0930 Saturday 3rd	Street	Total Length Available Kerb Space	Length of Junctions	Length of Bus stops/other	Unrestricted Kerb Space			Double Yellow Line				
					Length (m)	Calculated Spaces	Cars Parked	Stress	Length (m)	Calculated Spaces	Cars Parked	Stress
	The Street	178	5	17	146	29	10	34%	10	2	0	0%
	St Michaels Drive	286	5	57	224	44	15	34%				
<b>Total per Beat by restriction</b>						73	25	34%		2	0	0%
<b>Total per Beat</b>						73	25	34%				

1230 Saturday 3rd	Street	Total Length Available Kerb Space	Length of Junctions	Length of Bus stops/other	Unrestricted Kerb Space			Double Yellow Line				
					Length (m)	Calculated Spaces	Cars Parked	Stress	Length (m)	Calculated Spaces	Cars Parked	Stress
	The Street	178	5	17	146	29	14	48%	10	2	0	0%
	St Michaels Drive	286	5	57	224	44	15	34%				
<b>Total per Beat by restriction</b>						73	29	40%		2	0	0%
<b>Total per Beat</b>						73	29	40%				

1630 Saturday 3rd	Street	Total Length Available Kerb Space	Length of Junctions	Length of Bus stops/other	Unrestricted Kerb Space			Double Yellow Line				
					Length (m)	Calculated Spaces	Cars Parked	Stress	Length (m)	Calculated Spaces	Cars Parked	Stress
	The Street	178	5	17	146	29	13	45%	10	2	0	0%
	St Michaels Drive	286	5	57	224	44	13	30%				
<b>Total per Beat by restriction</b>						73	26	36%		2	0	0%
<b>Total per Beat</b>						73	26	36%				



**Appendix 6**  
**Vehicle Tracking assessments**

A3 SHEET @ 1:500

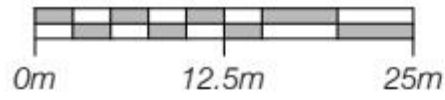

This drawing is copyright and must not be reproduced in whole or part without obtaining written authority from John Finch Partnership. Do not scale from this drawing. All dimensions to be checked on site. Refer any discrepancies to the project Architect.



**Accommodation Schedule**

Plot No.	Accommodation	Area (m <sup>2</sup> )	Amenity (m <sup>2</sup> )
01	4 Bedroom 7 person house	110	108
02	4 Bedroom 7 person house	110	104
03	4 Bedroom 7 person house	110	104
04	4 Bedroom 7 person house	110	104
05	4 Bedroom 7 person house	110	110
06	1 Bedroom 2 person apartment	60	4
G1/2	Private Double Garage	42	

**Key:**

- Retained Tree
- Proposed Tree
- Permeable gravel driveway
- Concrete pavers
- Cycle Stores
- Bins
- 1800mm h. close boarded timber fence
- 1800mm h. 225mm thick external brick wall

revision \_\_\_\_\_

issue **PLANNING**

client \_\_\_\_\_

Chelmsford City Council

project \_\_\_\_\_

Medway Close, Chelmsford

title \_\_\_\_\_

Proposed Block Plan

**john finch partnership**  
chartered architects & town planning consultants



88 Broomfield Road  
Chelmsford CM1 1SS  
01245 354319/250780  
admin@johnfinchpartnership.co.uk

www.johnfinchpartnership.co.uk

date	08.11.22	scale	1:500 @ A3
drawn	jm/jh	checked	jm
dwg no	3556:02	revision	D

**Vehicle dimensions**

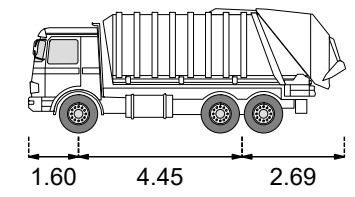

**ECC Refuse Collector (3 axled) - Custom**

- Length: 8.74 m
- Max width: 2.50 m
- Lock to lock time: 6.0 s
- Max steering angle: 35.33°
- Turn radius (curb to curb): 8.75 m

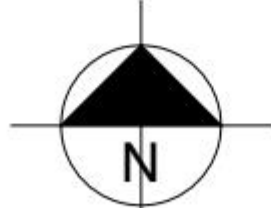

Site Area = 0.23ha



A3 SHEET @ 1:500

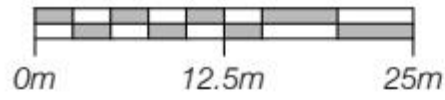

This drawing is copyright and must not be reproduced in whole or part without obtaining written authority from John Finch Partnership. Do not scale from this drawing. All dimensions to be checked on site. Refer any discrepancies to the project Architect.



**Accommodation Schedule**

Plot No.	Accommodation	Area (m <sup>2</sup> )	Amenity (m <sup>2</sup> )
01	4 Bedroom 7 person house	110	108
02	4 Bedroom 7 person house	110	104
03	4 Bedroom 7 person house	110	104
04	4 Bedroom 7 person house	110	104
05	4 Bedroom 7 person house	110	110
06	1 Bedroom 2 person apartment	60	4
G1/2	Private Double Garage	42	

**Key:**

- Retained Tree
- Proposed Tree
- Permeable gravel driveway
- Concrete pavers
- Cycle Stores
- Bins
- 1800mm h. close boarded timber fence
- 1800mm h. 225mm thick external brick wall

revision	
issue	PLANNING
client	Chelmsford City Council
project	Medway Close, Chelmsford
title	Proposed Block Plan

**john finch partnership**  
 chartered architects & town planning consultants



88 Broomfield Road  
 Chelmsford CM1 1SS  
 01245 354319/250780  
 admin@johnfinchpartnership.co.uk

www.johnfinchpartnership.co.uk

date	08.11.22	scale	1:500 @ A3
drawn	jm/jh	checked	jm
dwg no	3556:02	revision	D

**Vehicle dimensions**

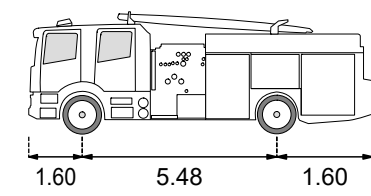

**Fire Appliance - Custom**

- Length: 8.68 m
- Max width: 2.40 m
- Lock to lock time: 4.0 s
- Max steering angle: 42.02°
- Turn radius (curb to curb): 9.11 m
- Turn radius (wall to wall): 10.16 m

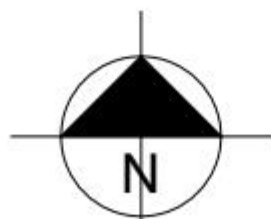

Site Area = 0.23ha